

ZAXIS470



HYDRAULIC EXCAVATOR

Model Code : ZX470-5G / ZX470LC-5G / ZX470H-5G / ZX470LCH-5G

Engine Rated Power : 235 kW (315 HP)

Operating Weight : ZX470-5G : 45 600 kg / ZX470LC-5G : 46 800 kg

ZX470H-5G : 46 700 kg / ZX470LCH-5G : 47 800 kg

Backhoe Bucket : ISO Heaped : 1.15 - 2.65 m³

ZAXIS Empower your Vision.

A ZAXIS hallmark – industry-leading hydraulic technologies, and performance no other can beat.

New ZAXIS provides reliable solutions: impressive fuel economy, swift front movements, and easy operation. You'll also find Hitachi technological prowess and expertise, such as the optimized hydraulic system and engine.

New ZAXIS features the key benefits of high quality, low fuel consumption, and high durability, all of which serve to ensure low running costs.

New ZAXIS, which is empowered by comprehensive evolution, will realize customers' visions and dreams, and pioneer your colorful future.



Key Benefits for Low Running Costs

- High Quality
- Low Fuel Consumption
- High Durability

Large Production with Less Fuel

Page 4-5

- 8% reduction in fuel consumption
- More fuel reduction in the ECO mode
- Swift front movements with HIOS III B hydraulics
- Enhanced basic performance
- Easy-to-use attachments

No Compromise on Operator Comfort

Page 8-9

- Comfortable operating environment
- Comfort-designed operator seat
- Robust cab
- New, easy-to-use multifunction monitor

Pursuits of Performance and Durability

Page 6-7

- Prestige R&D and quality control
- Durable, reliable engine
- Rock-solid, durable front attachment
- Strengthened fixed gauge undercarriage
- Proven upperstructure

Simplified Maintenance

Page 10-11

- Grouped remote inspection points
- Fast lubrication
- Easy-access to the upperstructure
- Low life cycle costs
- 705 L large capacity fuel tank

Hitachi Support Chain

Page 12-13

- Remote fleet management with Global e-Service
- Parts and service



Large Production with Less Fuel

8%* Reduction in Fuel Consumption

New ZAXIS is a fuel-thrifty excavator that can reduce fuel consumption by 8%*, compared to the conventional ZX450-3/ ZX450-3F family, thanks to the HIOS III B hydraulic system and engine control system, thereby reducing CO2 emissions.

*PWR mode vs. conventional model's P mode

More Fuel Reduction in the ECO mode

The ECO mode, a new economical mode, can further cut fuel consumption by 9% compared to the PWR mode, without sacrificing digging force by optimal matching of operations.



Swift Front Movements with HIOS* III B Hydraulics

Operating speed increases with less fuel consumption thanks to the HIOS III B hydraulic system, developed by industry-leading hydraulic technologies and a wealth of experience.

*Human & Intelligent Operation System

Improved Arm Controllability

Improved arm controllability for level luffing and level crowding for front movements, including swing operations. The boom regenerative circuit using the boom weight and the newly adopted variable orifice of the swing circuit help ensure hydraulic oil can be effectively allocated and pressure loss can be reduced.

Enhanced Basic Performance

The new ZAXIS offers enhanced basic performance, in addition to a sophisticated hydraulic control system like HIOS III B. For example, the boom circuit of the control valve was changed to an external flow combining circuit from the internal one to reduce energy loss when raising or lowering the boom. In addition, the power-boosting pressure function was enhanced to increase basic performance.

- 8% increased in swing torque
- 3% increased in traction force
- 3% increased in boom lifting capacities
- 3% increased in arm digging force*
- 3% increased in bucket digging force*

(compared to the conventional ZX450-3 / ZX450-3F family)

*At power boost

Easy-to-Use Attachments

The operator can change over valves, adjust extra circuit flow, and check settings from the multifunction monitor next to the operator seat. What's more, 11 jobs, including flow rate setting, can easily be selected by their identified names.

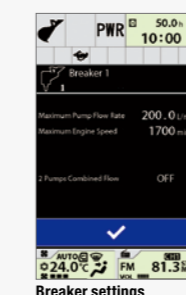

Pursuits of Performance and Durability

Prestige R&D and Quality Control

Hitachi has earned praise for technological prowess and product performance around the world. R&D Division has a track record – including excellent design, stress analysis expertise using CAE system, and abundant production data base. What's more, a large-scale durability test field (427 hm²) allows for a series of stringent testing of new machines. Production Division strives to automatize production processes, including robotic welding, machining, painting, assembling and transferring.



Computer-Aided Engineering



Main pump testing area



Main frame welding line



Large-sized excavator assembly line



Simulation testing from operator seat

Durable, Reliable Engine

This engine has a track record showing impressive durability at countless tough job sites around the world. The engine — associated with a rugged design, a direct fuel injection system and an elaborate governor — goes green, and complies with EU Stage II and US EPA Tier 2 emissions regulations.

A simple cooling system, consisting of a radiator and oil cooler, facilitates smooth cooling air flow for improved cooling efficiency. The combination of a 235 kW (315 HP) engine and the new HIOS IIIB hydraulic system meets requirements, in terms of both output and fuel consumption.



Rock-Solid, Durable Front Attachment

The new ZAXIS adopts the boom and arm used for heavy-duty versions of the conventional ZAXIS series to the ZX470-5G/ ZX470LC-5G standard models to increase the strength, allowing it to function optimally at tough job sites such as mines / quarries, where an endless stream of operations are required. It also has a wide applicable scope by using a bucket for civil engineering work or one for quarrying, depending on the intended use.

The arm cylinder, boom cylinders and bucket cylinder for the retract side cushion shocks at the stroke ends to reduce noise and extend the service life.

Strengthened Fixed Gauge Undercarriage

The new undercarriage is an integral construction, the track center and side frame of which are welded together. The lower center of gravity of the body improves stability. For idler brackets, where stress is concentrated in transit, the box-structure and reinforcing plates limit deformation and enhance travel stability. An enhanced two-step side step ladder is also provided to facilitate entering/alighting from the cab.

Proven Upperstructure

The upperstructure frame is reinforced with the proven D-section skirt to increase rigidity against damage by obstacles. A large door catch is added to reduce shocks and jolts of the cab and upperstructure.



Enhancements of boom & arm with rock bucket



Boom hose protector



Idler brackets



Fixed Gauge Undercarriage



Side step

No Compromise on Operator Comfort

Comfortable Operating Environment

You'll feel comfortable and confident, with plenty of leg space and excellent visibility when entering the cab. The new compact console gives more leg space. The new door pillar is shifted rearward by 70 mm to widen an entry space for easy access. A new LED room light, interlocked with the door, turns on when the door opens. The front window is easily removed and stored overhead using slide rails (ZX470(LC)-5G only). The overhead window is openable for ventilation. Lots more air vents for air conditioner are located strategically for uniform air circulation inside the cab. The control panel and control levers are arranged within easy reach of the operator. AM/FM radio and AUX port (optional) for a mobile music player are available for a long work day with less fatigue. All these designs focus on operator comfort.

Comfort-Designed Operator Seat

The luxury cloth seat is fitted with a headrest and arm rests for operator comfort. The seat can be adjusted in multiple ways, sliding and reclining, to suit operator's size and preferences. The seat can slide rearward by 40 mm more for added leg space. An air suspension with a heat pad is optional.

Robust Cab

The robust cab, meeting the OPG (Top Guard Level 1*), protects the operator from falling objects. The pilot control shut-off lever is provided with the neutral engine start system that permits engine starting only when the pilot control shut-off lever is in Lock position. The engine is lockable by entering a password through the 10-key panel.

*The H-series complies with Top Guard Level II.



Control panel

Large storage space



The photo shows an optional air suspension seat

New, Easy-to-Use Multifunction Monitor

The new multi-language, multifunction monitoring system is composed of a 7-inch high-resolution color monitor and a multifunction controller. The monitor allows the operator to check varying operating variables: hydraulic oil temperature, fuel level, work mode, full-auto air conditioner, AM/FM radio, rear view monitor camera (optional), maintenance support, and attachment flow adjustment. Menu items can be selected and adjusted by a multifunction controller on the control panel. A new rear view monitor camera always displays the view behind the machine.



Simplified Maintenance



Grouped Remote Inspection Points

Inspection points are concentrated inside left and right covers that are readily accessible from ground level for convenient servicing and inspection, including water draining from the fuel tank, replenishment of filters. A lid behind the cab door is available for easy replacement of the air conditioner filters for fresh air.

Easy-Access to the Upperstructure

A large sidewalk is provided on the left side of the cab, making it easy to access the engine from the ladder while handrails are provided and sufficient slip-resistant plates for safety.

Fast Lubrication

The arm and boom have their own centralized greasing points for fast lubrication. An optional electric grease gun with hose-reel is also available for faster greasing / lubrication.

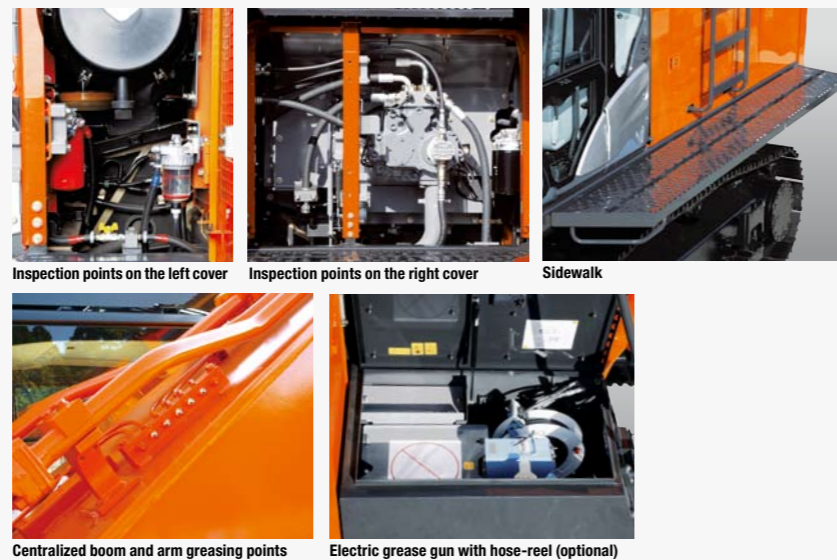

Low Life Cycle Costs

Service intervals are long enough to slash maintenance costs.

705 L Large Capacity Fuel Tank

Equipped with a large capacity fuel tank for longer operations.

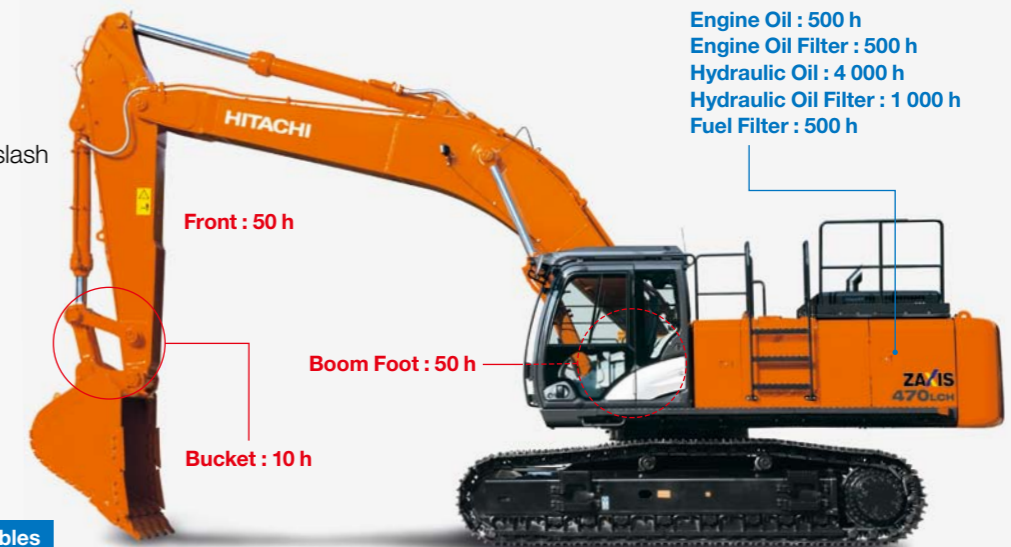

Lubricant Consumables

Note: Periodic inspection is required to check oil contamination and likes.

Hitachi Support Chain

Hitachi Support Chain is a full customer support system offered after buying a Hitachi machine.

Remote Fleet Management with Global e-Service

Easy Access to On-Site Machines through the Internet

This on-line fleet management system allows you to access each on-site machine from a PC in your office. You can get its operating information and location to increase productivity of the fleet and reduce downtime. Operating data and log are sent to a Hitachi server for processing, and then to customer and dealers around the world. This system is available 24 hours a day, all the year around.

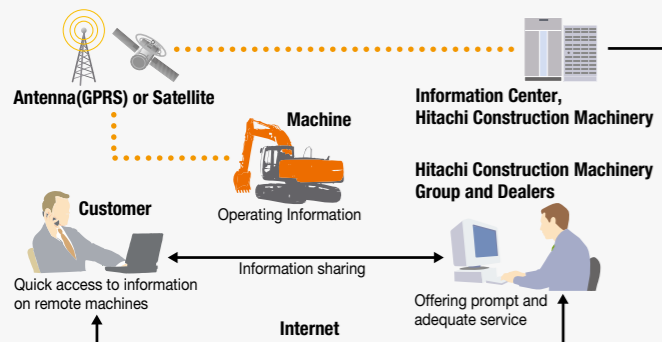

Note: In Some Regions, Global e-Service Is Not Available by Local Regulations.

Main Features of Global e-Service

Functions

Global e-Service provides easy access to a machine on site, conveying operating information and log, including daily operating hours, fuel level, temperatures, pressures, and likes.

Maintenance

Maintenance data and log are displayed on a easy-to-read monitor screen, suggesting recommended maintenance for efficient fleet management.

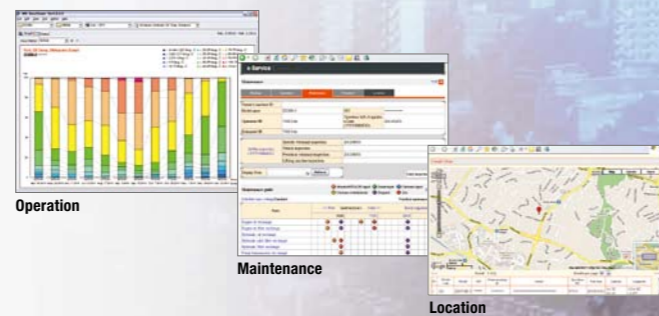

Parts and Service

Hitachi full customer support is available every area on the globe for full customer satisfaction through Hitachi local dealers.

Parts

Hitachi Global Online Network, a parts supply system, is linked with Japan Parts Center, overseas depots and over 150 dealers abroad to deliver on-line parts information, including in-stock parts, order receptions, shipments and delivery period of over one million parts and components.

Genuine Hitachi Parts

Genuine Hitachi parts, meeting Hitachi stringent quality standards, are guaranteed according to Hitachi warranty standards. The use of genuine Hitachi parts, including engine, fuel, hydraulic oil and filters, may slash running costs, and extend machine life.

Ground Engaging Tools (GETs)

Hitachi provides an array of Hitachi Ground Engaging Tools developed and built for a variety of applications.

Using high-quality, well-maintained GETs will help you get customers' trust.

Note: Some dealers do not handle Hitachi GETs.

Remanufactured Components

Hitachi components are remanufactured according to the stringent remanufacturing standards at factories around the world. They have high quality equivalent to new ones, and backed up by Hitachi warranty system.

Note: Some dealers do not handle Hitachi Remanufactured Components.

Service

Extended Warranty – HELP

Hitachi Standard Warranty System is available on all new Hitachi machines. In addition, Hitachi offers Hitachi Extended Life Programs (HELPS) to suit customer expectations –

protecting machines under tough operating conditions, avoiding unexpected downtime, and reducing repair costs.

Note: Warranty conditions vary by equipment.

Diagnostic Tools – Maintenance Pro

Electronic control system needs quick on-site solutions, apart from mechanical repairs. Hitachi's Maintenance Pro can diagnose machine failures in a short time by plugging a PC into a failed machine.

Technical Training

On-site servicing matters despite locations to keep the machine at peak performance and reduce downtime. Technical Training Center (TTC), located in Japan, educates and trains service technicians and service support personnel coming from Hitachi dealers and factories on the globe according to the international training programs.

SPECIFICATIONS

ENGINE

Model	Isuzu AA-6WG1TQA
Type	4-cycle water-cooled, direct injection
Aspiration	Turbocharged
No. of cylinders	6
Rated power	
ISO 9249, net	H/P mode:
(With Fan)	235 kW (315 HP) at 1 800 min ⁻¹ (rpm)
SAE J1349, net	H/P mode:
(With Fan)	231 kW (310 HP) at 1 800 min ⁻¹ (rpm)
Maximum torque	1 275 Nm (130 kgf m) at 1 500 min ⁻¹ (rpm)
Piston displacement ..	15.681 L
Bore and stroke	147 mm x 154 mm
Batteries	2 x 12 V / 170 Ah

HYDRAULIC SYSTEM

Hydraulic Pumps

Main pumps	2 variable displacement axial piston pumps
Maximum oil flow ..	2 x 360 L/min
Pilot pump	1 gear pump
Maximum oil flow ..	30 L/min

Hydraulic Motors

Travel	2 axial piston motors with parking brake
Swing	2 axial piston motors

Relief Valve Settings

Implement circuit	31.9 MPa (325 kgf/cm ²)
Swing circuit	28.4 MPa (290 kgf/cm ²)
Travel circuit	35.3 MPa (360 kgf/cm ²)
Pilot circuit	3.9 MPa (40 kgf/cm ²)
Power boost	35.3 MPa (360 kgf/cm ²)

Hydraulic Cylinders

	Quantity	Bore	Rod diameter
Boom	2	170 mm	115 mm
Arm	1	190 mm	130 mm
Bucket	1	170 mm	120 mm

UPPERSTRUCTURE

Revolving Frame

D-section frame for resistance to deformation.

Swing Device

Axial piston motor with planetary reduction gear is bathed in oil. Swing parking brake is spring-set/hydraulic-released disc type.

Swing speed

Operator's Cab

ZX470-5G / ZX470LC-5G:

Independent spacious cab, 1 025 mm wide by 1 675 mm high. The OPG top guard fitted Level I conforms to the related requirements of the International Organization for Standardization (ISO) 10262.

ZX470H-5G / ZX470LCH-5G (H/R cab):

Independent spacious cab, 1 025 mm wide by 1 817 mm high. The OPG top guard fitted Level II conforms to the related requirements of the International Organization for Standardization (ISO) 10262.

UNDERCARRIAGE

Tracks

Track shoes with triple grousers made of induction-hardened rolled alloy. Heat-treated connecting pins with dirt seals. Hydraulic (grease) track adjusters with shock-absorbing recoil springs.

Numbers of Rollers and Shoes on Each Side

Upper rollers	2
Lower rollers	8: ZX470-5G / ZX470H-5G 9: ZX470LC-5G / ZX470LCH-5G
Track shoes	49: ZX470-5G / ZX470H-5G 53: ZX470LC-5G / ZX470LCH-5G
Idler track guard	1: ZX470-5G / ZX470LC-5G
Track guard	1: ZX470-5G 2: ZX470LC-5G Full track guard : ZX470H-5G / ZX470LCH-5G

Travel Device

Each track driven by axial piston motor through reduction gear for counterrotation of the tracks. Parking brake is spring-set/hydraulic-released disc type.

Automatic transmission system: High-Low.

Travel speeds

Maximum traction force ..

Gradeability

SERVICE REFILL CAPACITIES

Fuel tank	705.0 L
Engine coolant	61.0 L
Engine oil	55.0 L
Swing device (each side)	6.5 L
Travel device (each side)	11.0 L
Hydraulic system	510.0 L
Hydraulic oil tank	310.0 L

WEIGHTS AND GROUND PRESSURE

Operating Weight and Ground Pressure

Shoe type	Shoe width	Boom type	Arm type	ZX470-5G		ZX470LC-5G		ZX470H-5G		ZX470LCH-5G	
				kg	kPa (kgf/cm ²)	kg	kPa (kgf/cm ²)	kg	kPa (kgf/cm ²)	kg	kPa (kgf/cm ²)
Triple or double grouser	600 mm	7.0 m H	3.4 m H	45 600	85 (0.87)	46 800	79 (0.81)	46 700	87 (0.89)	47 800	81 (0.83)
		Bucket capacity		1.9 m ³		2.1 m ³		1.9 m ³ Rock bucket		1.9 m ³ Rock bucket	
		6.3 m BE	2.5 m BE	46 000	86 (0.87)	47 400	80 (0.82)	–	–	48 300	82 (0.84)
Triple grouser	750 mm	Bucket capacity		2.5 m ³		2.65 m ³		–		2.5 m ³ Rock bucket	
		7.0 m H	3.4 m H	46 300	69 (0.70)	47 600	65 (0.66)	–	–	–	–
		Bucket capacity		1.9 m ³		2.1 m ³		–		–	
		6.3 m BE	2.5 m BE	46 700	70 (0.71)	48 100	65 (0.67)	–	–	–	–
Bucket capacity		2.5 m ³		2.65 m ³		–		–		–	

BUCKET LIST

ZX470-5G

Capacity	Width		No. of teeth	Weight	Recommendation						
	ISO heaped	Without side cutters			With side cutters	6.3 m BE-boom		7.0 m H-boom			
						2.5 m BE-arm	2.9 m BE-arm	2.9 m BE-arm	3.4 m H-arm	3.9 m arm	4.9 m arm
1.15 m ³	1 100 mm	1 210 mm	5	1 070 kg	×	×	×	×	×	○	
1.40 m ³	1 280 mm	1 410 mm	5	1 170 kg	×	×	×	×	×	○	
1.60 m ³	1 220 mm	1 360 mm	5	1 480 kg	–	–	○	○	○	×	
1.90 m ³	1 400 mm	1 540 mm	5	1 590 kg	–	–	○	○	○	×	
2.10 m ³	1 490 mm	1 630 mm	5	1 650 kg	–	–	○	○	–	×	
2.30 m ³	1 520 mm	1 660 mm	5	1 800 kg	○	○	○	–	–	×	
2.50 m ³	1 630 mm	1 770 mm	5	1 870 kg	○	○	–	–	–	×	
2.65 m ³	1 720 mm	1 860 mm	5	1 930 kg	○	–	–	–	–	×	
Applicable shoe type					600 mm Triple grouser or double grouser 750 mm Triple grouser						

ZX470LC-5G

Capacity	Width		No. of teeth	Weight	Recommendation							
	ISO heaped	Without side cutters			With side cutters	6.3 m BE-boom		7.0 m H-boom				8.2 m boom
						2.5 m BE-arm	2.9 m BE-arm	2.9 m BE-arm	3.4 m H-arm	3.9 m arm	4.9 m arm	
1.15 m ³	1 100 mm	1 210 mm	5	1 070 kg	×	×	×	×	×	○	○	
1.40 m ³	1 280 mm	1 410 mm	5	1 170 kg	×	×	×	×	×	○	×	
1.60 m ³	1 220 mm	1 360 mm	5	1 480 kg	–	–	○	○	○	×	×	
1.90 m ³	1 400 mm	1 540 mm	5	1 590 kg	–	–	○	○	○	×	×	
2.10 m ³	1 490 mm	1 630 mm	5	1 650 kg	–	–	○	○	○	×	×	
2.30 m ³	1 520 mm	1 660 mm	5	1 800 kg	○	○	○	○	–	×	×	
2.50 m ³	1 630 mm	1 770 mm	5	1 870 kg	○	○	–	–	–	×	×	
2.65 m ³	1 720 mm	1 860 mm	5	1 930 kg	○	○	–	–	–	×	×	
Applicable shoe type					600 mm Triple grouser or double grouser 750 mm Triple grouser							

ZX470H-5G/ZX470LCH-5G

Capacity	Width		No. of teeth	Weight	Recommendation								
	ISO heaped	Without side cutters			With side cutters	ZX470H-5G				ZX470LCH-5G			
						6.3 m BE-boom	7.0 m H-boom	6.3 m BE-boom	7.0 m H-boom				
*1 1.90 m ³	1 480 mm	1 500 mm	5	2 070 kg	●	●	●	●	●	●	●	●	
*1 2.10 m ³	1 560 mm	1 580 mm	5	2 170 kg	●	●	●	–	●	●	●	–	
*1 2.30 m ³	1 680 mm	1 700 mm	5	2 260 kg	●	–	–	–	●	●	–	–	
*1 2.50 m ³	1 800 mm	1 820 mm	5	2 360 kg	–	–	–	–	●	–	–	–	
*2 1.30 m ³	1 170 mm	–	3	2 330 kg	●	●	●	●	●	●	●	●	
One-point ripper			1	1 260 kg	●	●	●	●	●	●	●	●	
Applicable shoe type					600 mm Triple grouser or double grouser								

*1 Rock bucket

*2 Ripper bucket

● Heavy-duty service

○ Suitable for material with density of 1 600 kg / m³ or less

○ Suitable for material with density of 1 800 kg / m³ or less

– Not applicable

× Can't be installed

SPECIFICATIONS

WORKING RANGES

ZX470-5G / ZX470LC-5G

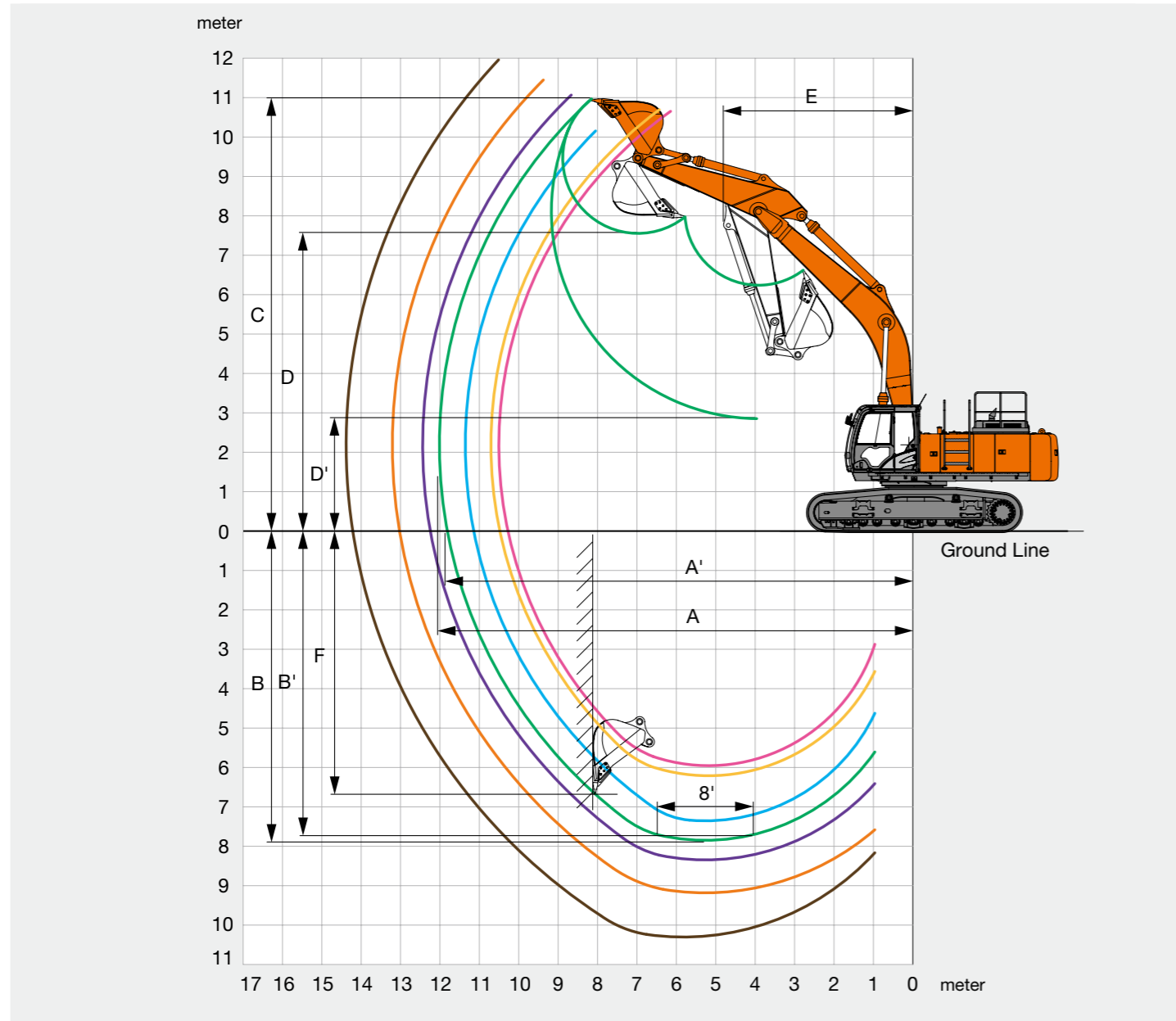

Unit: mm

Arm length	ZX470-5G / ZX470LC-5G						ZX470LC-5G
	6.3 m BE-boom		7.0 m H-boom				8.2 m Boom
	2.5 m BE-arm	2.9 m BE-arm	2.9 m H-arm	3.4 m H-arm	3.9 m Arm	4.9 m Arm	4.9 m Arm
A Max. digging reach	10 460 / 10 550	10 850 / 10 750	11 400 / 11 400	12 060 / 12 060	12 490 / 12 490	13 260 / 13 260	14 430
A' Max. digging reach (on ground)	10 240 / 10 320	10 640 / 10 520	11 200 / 11 220	11 860 / 11 860	12 300 / 12 290	13 080 / 13 070	14 260
B Max. digging depth	5 920 / 5 960	6 360 / 6 210	7 400 / 7 360	7 890 / 7 850	8 390 / 8 350	9 230 / 9 190	10 310
B' Max. digging depth (8' level)	5 740 / 5 780	6 200 / 6 050	7 200 / 7 160	7 750 / 7 710	8 270 / 8 230	9 110 / 9 070	10 190
C Max. cutting height	10 530 / 10 660	10 760 / 10 710	10 130 / 10 170	10 920 / 10 960	11 040 / 11 080	11 420 / 11 460	11 980
D Max. dumping height	7 190 / 7 160	7 210 / 7 360	6 900 / 6 910	7 530 / 7 570	7 650 / 7 690	8 390 / 8 430	8 980
D' Min. dumping height	3 550 / 3 510	3 030 / 3 170	3 320 / 3 330	2 820 / 2 860	2 320 / 2 360	1 490 / 1 530	2 270
E Min. swing radius	3 930 / 3 930	3 920 / 3 920	5 020 / 5 020	4 840 / 4 840	4 810 / 4 810	4 850 / 4 850	5 870
F Max. vertical wall	4 380 / 4 230	5 150 / 4 740	5 390 / 4 780	6 710 / 6 670	7 100 / 7 060	8 470 / 8 430	9 280

Excluding track shoe lug

WORKING RANGES

ZX470H-5G / ZX470LCH-5G

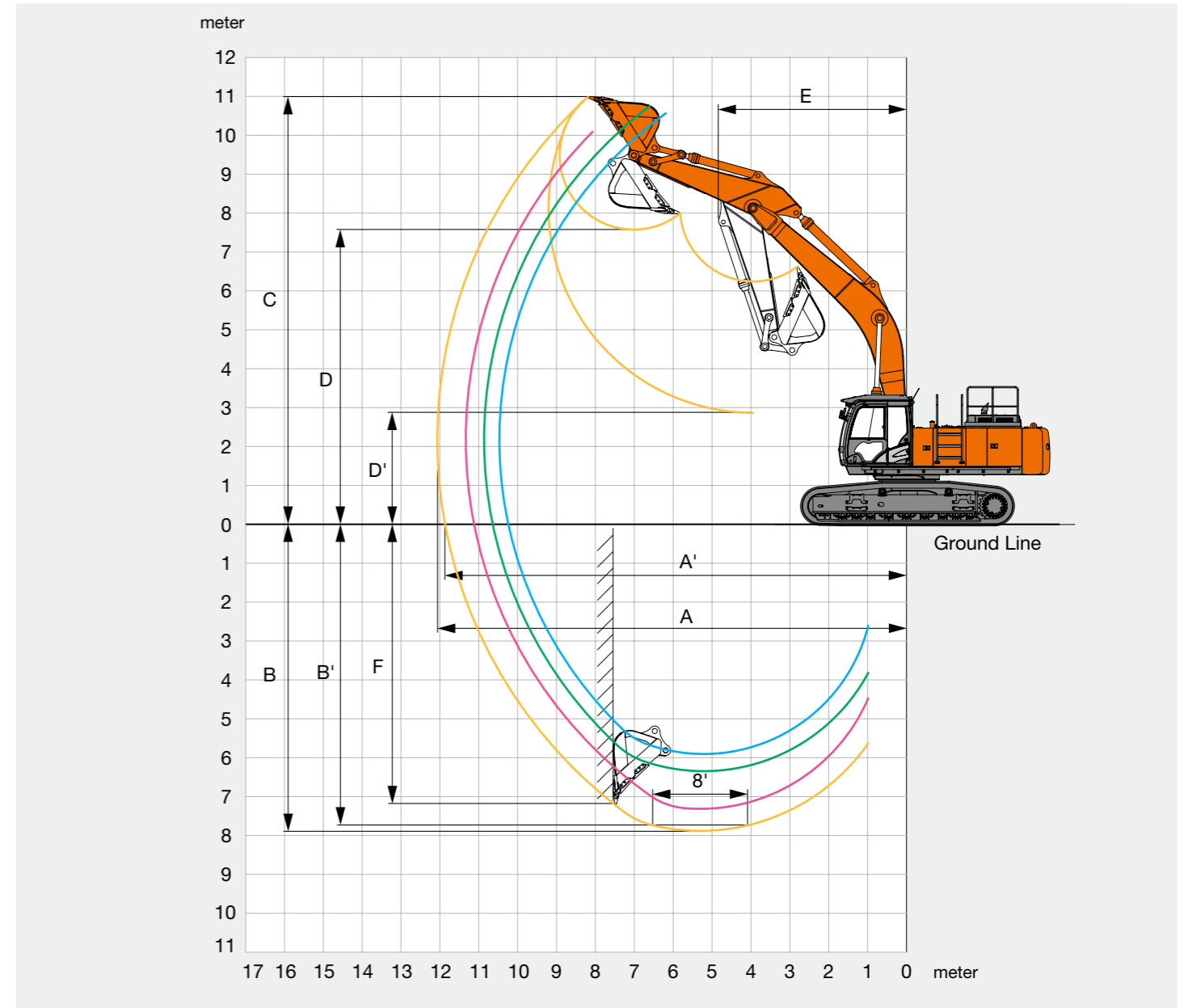

Unit: mm

Arm length	ZX470H-5G		ZX470LCH-5G			
	7.0 m H-boom		6.3 m BE-boom		7.0 m H-boom	
	2.9 m BE-arm	3.4 m H-arm	2.5 m BE-arm	2.9 m BE-arm	2.9 m BE-arm	3.4 m H-arm
A Max. digging reach	11 330	12 060	10 460	10 750	11 330	12 060
A' Max. digging reach (on ground)	11 120	11 860	10 230	10 630	11 110	11 860
B Max. digging depth	7 330	7 900	5 880	6 220	7 290	7 860
B' Max. digging depth (8' level)	7 130	7 760	5 710	6 060	7 090	7 720
C Max. cutting height	10 040	10 920	10 570	10 700	10 080	10 980
D Max. dumping height	6 970	7 520	7 230	7 350	7 010	7 560
D' Min. dumping height	3 390	2 810	3 580	3 160	3 430	2 850
E Min. swing radius	5 020	4 840	4 090	3 930	5 020	4 840
F Max. vertical wall	4 400	7 230	4 350	4 740	4 360	7 190

Excluding track shoe lug

SPECIFICATIONS

DIMENSIONS

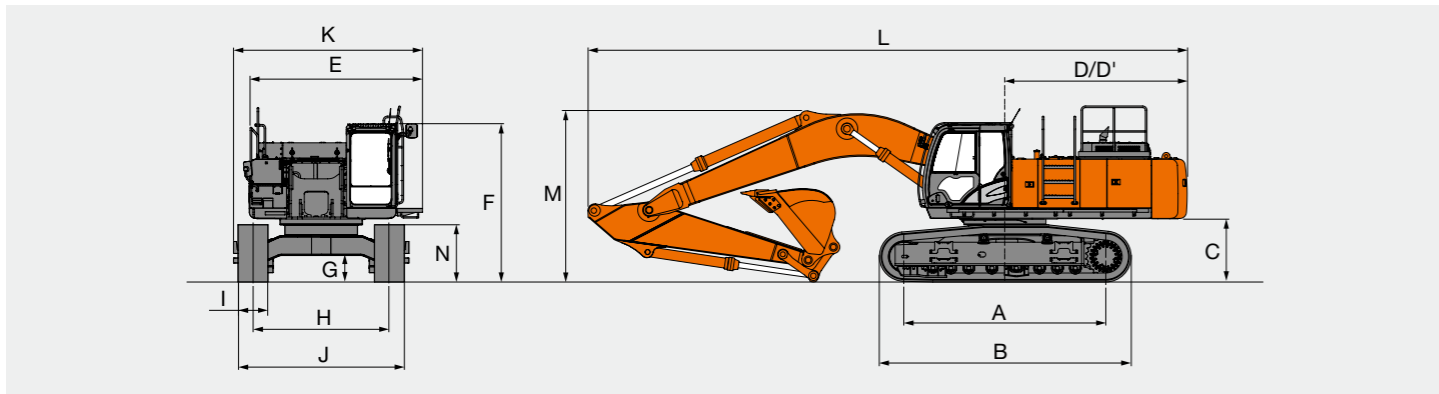

Unit: mm

Fixed gauge	ZX470-5G	ZX470LC-5G	ZX470H-5G	ZX470LCH-5G
A Distance between tumbler	4 040	4 470	4 040	4 470
B Undercarriage length	5 040	5 470	5 040	5 470
*1 C Counterweight clearance	1 230	1 270	1 230	1 270
D Rear-end swing radius	3 670	3 670	3 670	3 670
D' Rear-end length	3 660	3 660	3 660	3 660
E Overall width upperstructure	3 480	3 480	3 480	3 480
F Overall height of cab	3 170	3 210	3 280	3 320
*1 G Min. ground clearance	495	535	495	535
H Track gauge	2 740	2 740	2 740	2 740
I Track shoe width	600 / 750	600 / 750	600	600
J Undercarriage width	with 600 mm shoe 3 340	3 340	3 340	3 340
	with 750 mm shoe 3 490	3 490	—	—
K Overall width	3 820	3 820	3 820	3 820
L Overall length	12 050	12 050	12 040	12 040
M Overall height of boom	4 660	4 660	3 740	4 120
N Track height	1 150	1 150	1 150	1 150

*1 Excluding track shoe lug

BUCKET AND ARM DIGGING FORCES

ZX470-5G / ZX470LC-5G

	ZX470-5G / ZX470LC-5G						ZX470LC-5G
	6.3 m BE-boom		7.0 m H-boom				8.2 m boom
	2.5 m BE-arm	2.9 m BE-arm	2.9 m BE-arm	3.4 m H-arm	3.9 m arm	4.9 m arm	4.9 m arm
Bucket digging force* ISO	285 kN (29 130 kgf)	285 kN (29 130 kgf)	285 kN (29 130 kgf)	286 kN (29 230 kgf)	286 kN (29 230 kgf)	238 kN (24 290 kgf)	238 kN (24 290 kgf)
Bucket digging force* SAE : PCSA	257 kN (26 240 kgf)	257 kN (26 240 kgf)	254 kN (25 940 kgf)	256 kN (26 140 kgf)	256 kN (26 140 kgf)	213 kN (21 720 kgf)	213 kN (21 720 kgf)
Arm crowd force* ISO	294 kN (30 050 kgf)	256 kN (26 140 kgf)	259 kN (26 450 kgf)	222 kN (22 640 kgf)	201 kN (20 480 kgf)	177 kN (18 110 kgf)	177 kN (18 110 kgf)
Arm crowd force* SAE : PCSA	285 kN (29 130 kgf)	249 kN (25 420 kgf)	252 kN (25 730 kgf)	215 kN (21 920 kgf)	196 kN (19 970 kgf)	175 kN (17 800 kgf)	175 kN (17 800 kgf)

ZX470H-5G / ZX470LCH-5G

	ZX470H-5G		ZX470LCH-5G			
	7.0 m H-boom		6.3 m BE-boom		7.0 m H-boom	
	2.9 m BE-arm	3.4 m H-arm	2.5 m BE-arm	2.9 m BE-arm	2.9 m BE-arm	3.4 m H-arm
Bucket digging force* ISO	295 kN (30 150 kgf)	296 kN (30 260 kgf)	295 kN (30 150 kgf)	295 kN (30 150 kgf)	295 kN (30 150 kgf)	296 kN (30 260 kgf)
Bucket digging force* SAE : PCSA	266 kN (27 070 kgf)	257 kN (26 240 kgf)	266 kN (27 070 kgf)	266 kN (27 070 kgf)	266 kN (27 070 kgf)	257 kN (26 240 kgf)
Arm crowd force* ISO	263 kN (26 860 kgf)	224 kN (22 850 kgf)	302 kN (30 770 kgf)	263 kN (26 860 kgf)	263 kN (26 860 kgf)	224 kN (22 850 kgf)
Arm crowd force* SAE : PCSA	256 kN (26 140 kgf)	215 kN (21 920 kgf)	294 kN (30 050 kgf)	256 kN (26 140 kgf)	256 kN (26 140 kgf)	215 kN (21 920 kgf)

*At power boost

LIFTING CAPACITIES (Without bucket)

Notes: 1. Ratings are based on ISO 10567.

2. Lifting capacity does not exceed 75% of tipping load with the machine on firm, level ground or 87% full hydraulic capacity.

3. The load point is the center-line of the bucket pivot mounting pin on the arm.

4. *Indicates load limited by hydraulic capacity.

5. 0 m = Ground.

For lifting capacities, subtract bucket and quick hitch weight from lifting capacities without bucket.

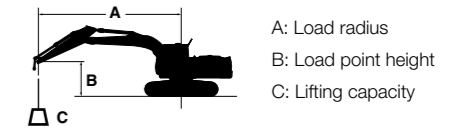

A: Load radius

B: Load point height

C: Lifting capacity

ZX470LC-5G

Rating over-front Rating over-side or 360 degrees Unit : kg

Conditions	Load point height m	Load radius m										At max. reach				
		3.0		4.5		6.0		7.5		9.0		meter				
		Rating over-front	Rating over-side or 360 degrees	Rating over-front	Rating over-side or 360 degrees	Rating over-front	Rating over-side or 360 degrees	Rating over-front	Rating over-side or 360 degrees	Rating over-front	Rating over-side or 360 degrees	meter	meter			
H-Boom 7.0 m H-Arm 3.4 m Counterweight 9 080 kg Shoe 600 mm	7.5															
	6.0															
	4.5			*20 430	*20 430	*15 620	13 510	*13 180	9 640	*11 770	7 240	*7 660	6 170	9.89		
	3.0			*24 960	18 930	*17 810	12 630	*14 350	9 180	11 840	7 000	*7 970	5 800	10.1		
	1.5			*15 420	*15 420	*19 460	11 920	15 250	8 770	11 580	6 770	*8 520	5 670	10.1		
	0 (Ground)			*18 160	17 400	*20 170	11 500	14 910	8 480	11 390	6 600	*9 410	5 770	9.91		
	-1.5	*13 070	*13 070	*25 000	17 380	*19 860	11 340	14 760	8 340	11 320	6 530	10 580	6 140	9.45		
	-3.0	*21 470	*21 470	*23 670	17 570	*18 500	11 390	*14 640	8 370			*11 830	6 910	8.70		
	-4.5	*24 850	24 850	*19 860	17 980	*15 700	11 660	*11 760	8 630			*11 480	8 510	7.59		
H-Boom 7.0 m BE-Arm 2.9 m Counterweight 9 080 kg Shoe 600 mm	6.0					*14 460	14 060	*12 780	9 890			*11 030	7 750	8.68		
	4.5			*22 080	20 230	*16 440	13 240	*13 720	9 490	11 990	7 140	*11 410	6 880	9.20		
	3.0					*18 470	12 380	*14 780	9 050	11 750	6 920	10 880	6 410	9.49		
	1.5					*19 840	11 750	15 140	8 680	11 530	6 720	10 690	6 250	9.47		
	0 (Ground)			*19 290	17 370	*20 180	11 420	14 870	8 430	11 380	6 590	10 980	6 370	9.23		
		-1.5	*15 470	*15 470	*24 940	17 460	*19 510	11 350	14 770	8 350			11 860	6 840	8.73	
	-3.0	*26 650	*26 650	*22 250	17 720	*17 750	11 470	*13 970	8 450			*12 920	7 890	7.92		
	-4.5			*17 910	*17 910	*14 270	11 830					*12 470	10 240	6.67		
BE-Boom 6.3 m BE-Arm 2.9 m Counterweight 9 080 kg Shoe 600 mm	7.5					*13 980	*13 980					*8 010	*8 010	7.13		
	6.0					*14 790	14 350	*13 540	9 980			*7 760	*7 760	8.05		
	4.5			*20 920	*20 920	*16 490	13 680	*14 230	9 690			*7 840	7 750	8.61		
	3.0			*25 210	19 560	*18 480	12 900	*15 170	9 310			*8 200	7 200	8.88		
	1.5			*27 650	18 390	*20 010	12 250	15 480	8 960			*8 900	7 030	8.89		
	0 (Ground)			*27 690	17 960	*20 550	11 860	15 210	8 730			*10 090	7 210	8.64		
	-1.5	*23 600	*23 600	*26 050	17 950	*19 860	11 740	15 140	8 670			*12 190	7 850	8.10		
	-3.0	*29 020	*29 020	*22 730	18 210	*17 540	11 880					*13 650	9 300	7.21		
BE-Boom 6.3 m BE-Arm 2.5 m Counterweight 9 080 kg Shoe 600 mm	7.5					*14 650	14 460					*12 320	11 740	6.77		
	6.0					*15 320	14 100	*14 020	9 780			*11 890	9 280	7.73		
	4.5			*21 800	20 830	*16 930	13 410	*14 540	9 520			*12 000	8 060	8.31		
	3.0					*18 780	12 640	*15 350	9 150			*12 550	7 450	8.59		
	1.5					*20 100	12 020	15 330	8 820			12 460	7 270	8.60		
	0 (Ground)			*27 160	17 750	*20 380	11 690	15 100	8 620			12 930	7 490	8.34		
	-1.5			*25 130	17 820	*19 370	11 630	*14 960	8 610			*14 100	8 230	7.78		
	-3.0			*21 380	18 150	*16 560	11 850					*13 670	9 950	6.85		

ZX470-5G

Rating over-front Rating over-side or 360 degrees Unit : kg

Conditions	Load point height m	Load radius m										At max. reach				
		3.0		4.5		6.0		7.5		9.0		meter				
		Rating over-front	Rating over-side or 360 degrees	Rating over-front	Rating over-side or 360 degrees	Rating over-front	Rating over-side or 360 degrees	Rating over-front	Rating over-side or 360 degrees	Rating over-front	Rating over-side or 360 degrees	meter	meter			
H-Boom 7.0 m H-Arm 3.4 m Counterweight 9 080 kg Shoe 600 mm	7.5															
	6.0															
	4.5			*20 300	*20 300	*15 560	13 250	*13 150	9 440	10 410	7 070	*7 660	6 030	9.88		
	3.0			*24 860	18 540	*17 760	12 360	13 420	8 970	10 150	6 830	*7 960	5 660	10.1		
	1.5			*15 450	*15 450	18 150	11 640	12 960	8 560	9 900	6 600	8 280	5 520	10.1		
	0 (Ground)			*18 020	16 970	17 670	11 220	12 640	8 260	9 710	6 430	8 450	5 610	9.92		
	-1.5	*12 850	*12 850	*24 770	16 940	17 480	11 050	12 480	8 120	9 640	6 360	9 000	5 960	9.47		
	-3.0	*21 230	*21 230	*23 750	17 130	17 530	11 100	12 510	8 150			10 150	6 700	8.73		
	-4.5	*25 030	*25 030	*19 990	17 530	*15 800	11 350	*11 890	8 400			*11 490	8 240	7.63		

LIFTING CAPACITIES (Without bucket)

Notes: 1. Ratings are based on ISO 10567.

2. Lifting capacity does not exceed 75% of tipping load with the machine on firm, level ground or 87% full hydraulic capacity.

3. The load point is the center-line of the bucket pivot mounting pin on the arm.

4. *Indicates load limited by hydraulic capacity.

5. 0 m = Ground.

For lifting capacities, subtract bucket and quick hitch weight from lifting capacities without bucket.

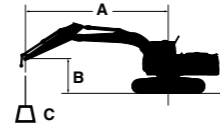

A: Load radius

B: Load point height

C: Lifting capacity

ZX470LCH-5G

Rating over-front Rating over-side or 360 degrees Unit : kg

Conditions	Load point height m	Load radius m										At max. reach					
		3.0		4.5		6.0		7.5		9.0				meter			
H-Boom 7.0 m H-Arm 3.4 m Counterweight 9 080 kg Shoe 600 mm	7.5																
	6.0																
	4.5																
	3.0																
	1.5																
	0 (Ground)																
	-1.5	*13 070	*13 070	*25 000	17 640	*19 860	11 520	14 970	8 470	11 480	6 640	10 740	6 230	9.45			
-3.0	*21 470	*21 470	*23 670	17 830	*18 500	11 570	*14 640	8 500			*11 830	7 020	8.70				
-4.5	*24 850	*24 850	*19 860	18 230	*15 700	11 830	*11 760	8 760			*11 480	8 640	7.59				
H-Boom 7.0 m BE-Arm 2.9 m Counterweight 9 080 kg Shoe 600 mm	6.0																
	4.5																
	3.0																
	1.5																
	0 (Ground)																
	-1.5	*15 470	*15 470	*24 940	17 710	*19 510	11 520	14 980	8 480	11 550	6 690	12 030	6 950	8.73			
	-3.0	*26 650	*26 650	*22 250	17 980	*17 750	11 640	*13 970	8 580			*12 920	8 010	7.92			
-4.5			*17 910	*17 910	*14 270	12 000					*12 470	10 390	6.67				
BE-Boom 6.3 m BE-Arm 2.5 m Counterweight 9 080 kg Shoe 600 mm	7.5																
	6.0																
	4.5																
	3.0																
	1.5																
	0 (Ground)																
	-1.5			*25 130	18 070	*19 370	11 800	*14 960	8 740			*14 110	8 350	7.78			
-3.0			*21 380	18 410	*16 560	12 020					*13 670	10 100	6.85				

ZX470H-5G

Rating over-front Rating over-side or 360 degrees Unit : kg

Conditions	Load point height m	Load radius m										At max. reach				
		3.0		4.5		6.0		7.5		9.0				meter		
H-Boom 7.0 m H-Arm 3.4 m Counterweight 9 080 kg Shoe 600 mm	7.5															
	6.0															
	4.5															
	3.0															
	1.5															
	0 (Ground)															
	-1.5	*12 850	*12 850	*24 770	17 200	17 740	11 230	12 680	8 250	9 790	6 460	9 140	6 060	9.47		
-3.0	*21 230	*21 230	*23 750	17 390	17 790	11 270	12 700	8 280			10 300	6 810	8.73			
-4.5	*25 030	*25 030	*19 990	17 790	*15 800	11 530	*11 890	8 530			*11 490	8 360	7.63			

TRANSPORTATION

BASIC MACHINE (WITHOUT COUNTERWEIGHT)

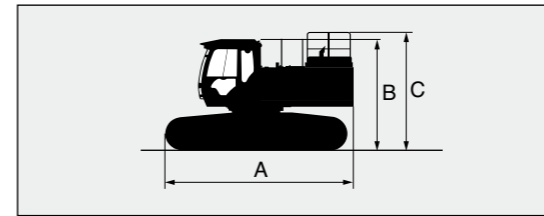

Fixed gauge	Shoe type	Shoe width	Overall width	Weight	A	B	C
ZX470-5G	Triple or double grouser	600 mm	3 340 mm	26 900 kg	5 470 mm	3 200 mm	3 540 mm
	Triple grouser	750 mm	3 490 mm	27 700 kg			
ZX470LC-5G	Triple or double grouser	600 mm	3 340 mm	28 100 kg	5 690 mm	3 240 mm	3 580 mm
	Triple grouser	750 mm	3 490 mm	28 900 kg			
ZX470H-5G	Triple or double grouser	600 mm	3 340 mm	27 500 kg	5 470 mm	3 320 mm	3 540 mm
ZX470LCH-5G	Triple or double grouser	600 mm	3 340 mm	28 700 kg	5 690 mm	3 360 mm	3 580 mm

BASIC MACHINE FITTED WITH BOOM AND NO SIDEWALK

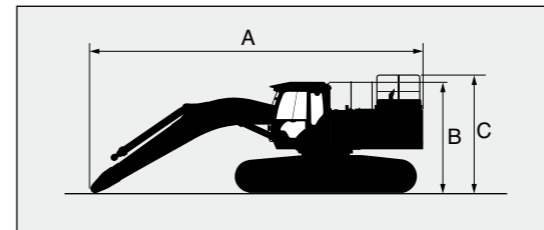

Fixed gauge	Boom length	Shoe type	Shoe width	Overall width	Weight	A	B	C
ZX470-5G	6.3 m BE	Triple or double grouser	600 mm	3 340 mm	32 300 kg	9 170 mm	3 200 mm	3 540 mm
		Triple grouser	750 mm	3 490 mm	33 000 kg			
	7.0 m H	Triple or double grouser	600 mm	3 340 mm	32 300 kg	9 950 mm		
		Triple grouser	750 mm	3 490 mm	33 000 kg			
ZX470LC-5G	6.3 m BE	Triple or double grouser	600 mm	3 340 mm	33 500 kg	9 160 mm	3 240 mm	3 580 mm
		Triple grouser	750 mm	3 490 mm	34 300 kg			
	7.0 m H	Triple or double grouser	600 mm	3 340 mm	33 500 kg	9 940 mm		
		Triple grouser	750 mm	3 490 mm	34 300 kg			
	8.2 m	Triple or double grouser	600 mm	3 340 mm	34 000 kg	11 190 mm		
		Triple grouser	750 mm	3 490 mm	34 800 kg			
ZX470H-5G	7.0 H m	Triple or double grouser	600 mm	3 340 mm	32 900 kg	9 950 mm	3 320 mm	3 540 mm
ZX470LCH-5G	6.3 m BE	Triple or double grouser	600 mm	3 340 mm	34 100 kg	9 160 mm	3 360 mm	3 580 mm
	7.0 H m	Triple or double grouser	600 mm	3 340 mm	34 000 kg	9 940 mm		

BASIC MACHINE WITH FRONT AND SIDEWALK

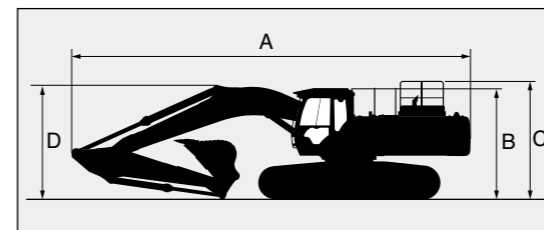

Fixed gauge	Boom length	6.3 m BE		7.0 m H				8.2 m	
		Arm length	2.5 m BE	2.9 m BE	2.9 m BE	3.4 m H	3.9 m	4.9 m	4.9 m
ZX470-5G	A	11 490 mm	11 300 mm	12 060 mm	12 040 mm	12 040 mm	11 880 mm	13 160 mm	
	B	3 200 mm							
	C	3 540 mm							
	D	4 020 mm	4 200 mm	3 860 mm	3 450 mm	3 480 mm	4 660 mm		
ZX470LC-5G	A	11 490 mm	11 290 mm	12 050 mm	12 070 mm	12 030 mm	11 900 mm	13 160 mm	
	B	3 240 mm							
	C	3 580 mm							
ZX470H-5G	A	/		12 100 mm		12 040 mm		/	
	B			3 320 mm					
	C	3 540 mm							
	D	/		3 740 mm	3 450 mm		/		
ZX470LCH-5G	A	11 490 mm	11 360 mm	12 100 mm	12 030 mm		/		
	B	3 360 mm							
	C	3 580 mm							
	D	4 130 mm	3 880 mm	3 740 mm	3 450 mm				

ARM AND BUCKET

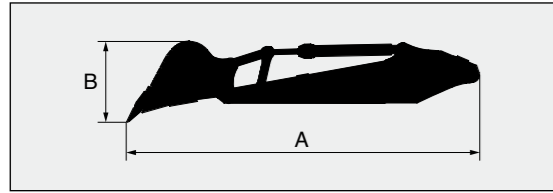

ZX470-5G / ZX470LC-5G

Arm	Bucket Capacity ISO heaped	A	B	Overall width	Weight
2.5 m BE	2.50 m ³	5 760 mm	1 400 mm	1 770 mm	4 620 kg
2.9 m BE	2.30 m ³	6 030 mm	1 340 mm	1 660 mm	4 350 kg
3.4 m H	1.90 m ³	6 430 mm	1 270 mm	1 540 mm	4 150 kg
	2.10 m ³	6 430 mm	1 270 mm	1 630 mm	4 210 kg
3.9 m	1.90 m ³	6 930 mm	1 270 mm	1 540 mm	4 230 kg
4.9 m	1.40 m ³	7 760 mm	1 170 mm	1 410 mm	3 720 kg

ZX470H-5G / ZX470LCH-5G

Arm	Bucket Capacity ISO heaped	A	B	Overall width	Weight
2.5 m BE	2.50 m ³	5 650 mm	1 470 mm	1 820 mm	5 010 kg
2.9 m BE	2.30 m ³	5 950 mm	1 460 mm	1 700 mm	4 800 kg
3.4 m H	1.90 m ³	6 440 mm	1 300 mm	1 500 mm	4 630 kg

BUCKET

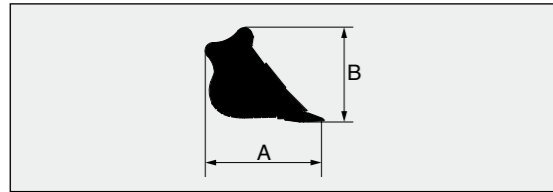

ZX470-5G / ZX470LC-5G (Hoe bucket)

Bucket Capacity ISO heaped	A	B	Overall width	Weight
1.15 m ³	1 800 mm	1 350 mm	1 210 mm	1 070 kg
1.40 m ³	1 800 mm	1 350 mm	1 410 mm	1 170 kg
1.60 m ³	1 960 mm	1 570 mm	1 360 mm	1 480 kg
1.90 m ³	1 960 mm	1 570 mm	1 540 mm	1 590 kg
2.10 m ³	1 960 mm	1 570 mm	1 630 mm	1 650 kg
2.30 m ³	1 950 mm	1 660 mm	1 660 mm	1 800 kg
2.50 m ³	1 950 mm	1 660 mm	1 770 mm	1 870 kg
2.65 m ³	1 950 mm	1 660 mm	1 860 mm	1 930 kg

ZX470H-5G / ZX470LCH-5G (Rock bucket)

Bucket capacity ISO heaped	A	B	Overall width	Weight
1.90 m ³	2 030 mm	1 480 mm	1 500 mm	2 070 kg
2.10 m ³	1 950 mm	1 650 mm	1 580 mm	2 170 kg
2.30 m ³	1 950 mm	1 650 mm	1 700 mm	2 260 kg
2.50 m ³	1 950 mm	1 650 mm	1 820 mm	2 360 kg

COUNTERWEIGHT 9 080 kg

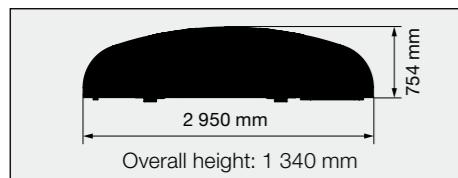

LEFT FRONT SIDEWALK 44 kg

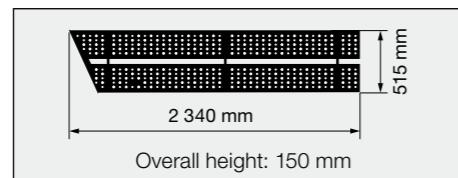

LEFT REAR SIDEWALK 30 kg

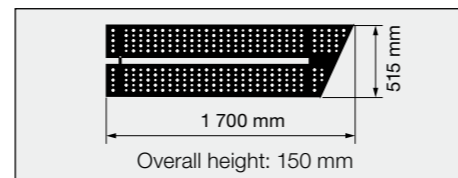

Standard and optional equipment may vary by country, so please consult your Hitachi dealer for details.

● : Standard equipment ○ : Optional equipment — : Not applicable

	ZX470-5G	ZX470LC-5G	ZX470H-5G	ZX470LCH-5G
ENGINE				
Auto idle system	●	●	●	●
Cartridge-type engine oil filter	●	●	●	●
Cartridge-type fuel filter	●	●	●	●
Dry-type air double filter with evacuator valve(with air filter restriction switch for monitor)	●	●	●	●
Fan guard	●	●	●	●
Fuel pre-filter	●	●	●	●
Power mood control [H/P (High Power) PWR(Power) ECO(Economy)]	●	●	●	●
Isolation-mounted engine	●	●	●	●
Pre-cleaner	○	○	○	○
Radiator, oil cooler with dust protective net	●	●	●	●
Radiator reserve tank	●	●	●	●
50 A alternator	●	●	●	●

HYDRAULIC SYSTEM				
Accessories for breaker	—	—	○	○
Accessories for breaker & crusher	—	—	○	○
Accessories for 2 speed selector	—	—	○	○
Auto power lift	●	●	●	●
Boom mode selector system	●	●	●	●
Control valve with main relief valve	●	●	●	●
Drain filter	●	●	●	●
Engine speed sensing system	●	●	●	●
E-P control system	●	●	●	●
Extra port for control valve	●	●	●	●
Full-flow filter	●	●	●	●
Hose rupture valve	○	○	○	○
Pilot filter	●	●	●	●
Power boost	●	●	●	●
Quick warm-up system for pilot circuit	●	●	●	●
Shockless valve in pilot circuit	●	●	●	●
Suction filter	●	●	●	●
Work mode selector	●	●	●	●

CAB				
Additional fuse box	●	●	●	●
Adjustable armrests	●	●	●	●
All-weather sound suppressed steel cab	●	●	●	●
AM-FM radio	●	●	●	●
Ashtray	●	●	●	●
Auto control air conditioner	●	●	●	●
Auto-idle selector	●	●	●	●
AUX. terminal and storage	○	○	○	○
Cab : (Center pillar reinforced structure)	●	●	—	—
OPG top guard fitted Level I (ISO10262) compliant cab	●	●	—	—
Round Tempered glass (green color) front window	●	●	—	—

	ZX470-5G	ZX470LC-5G	ZX470H-5G	ZX470LCH-5G
Front window on upper, lower and left side can be opened	●	●	—	—
H/R cab	—	—	●	●
OPG top guard fitted Level II (ISO10262)	—	—	●	●
OPG front guard fitted Level II (ISO10262)	—	—	○	○
Laminated straight glass front window	—	—	●	●
Left side window can be opened	—	—	●	●
Cigarette lighter	●	●	●	●
Drink holder	●	●	●	●
Engine shut-off cable	●	●	●	●
Electric double horn	●	●	●	●
Evacuation hammer	●	●	●	●
Fire extinguisher bracket	○	○	○	○
Floor mat	●	●	●	●
Footrest	●	●	●	●
Front window washer	●	●	●	●
Glove compartment	●	●	●	●
Hot & cool box	●	●	●	●
Intermittent windshield wiper	●	●	●	●
Key cylinder light	●	●	●	●
LED room light with door countesy	●	●	●	●
Pilot control shut-off lever	●	●	●	●
Rain guard for cab	○	○	—	—
Rear tray	●	●	●	●
Retractable seat belt	●	●	●	●
Rubber radio antenna	●	●	●	●
Seat : Adjustable reclining mechanical suspension	●	●	●	●
Seat : Adjustable reclining mechanical suspension with heater	○	○	○	○
Seat : Adjustable reclining air suspension with heater	○	○	○	○
Short wrist control levers	●	●	●	●
Storage box	●	●	●	●
Sun visor (front)	○	○	○	○
Sun visor (side)	○	○	○	○
Transparent roof with slide curtain	—	—	●	●
2 speaker	●	●	●	●
6 fluid-filled elastic mounts	●	●	●	●
12 V power outlet	○	○	○	○
24 V cigarette lighter	●	●	●	●

MONITOR SYSTEM				
Alarm buzzers: overheat, engine oil pressure	●	●	●	●
Alarms: overheat, engine warning, engine oil pressure, alternator, minimum fuel level, air filter restriction, work mode, etc	●	●	●	●
Display of meters: water temperature, hour, fuel rate, clock	●	●	●	●
Other displays: work mode, auto-idle, glow, operating conditions etc	●	●	●	●

EQUIPMENT

Standard and optional equipment may vary by country, so please consult your Hitachi dealer for details.

● : Standard equipment ○ : Optional equipment — : Not applicable

	ZX470-5G	ZX470LC-5G	ZX470H-5G	ZX470LCH-5G
LIGHTS				
2 working lights	●	●	●	●
2 cab lights	○	○	●	●
4 cab lights	○	○	○	○
Additional working lights (boom right side)	○	○	○	○

UPPER STRUCTURE				
Electric fuel refilling pump with auto stop	○	○	○	○
Auto-grease lubricator	○	○	○	○
Electrical grease pump with hose-reel	○	○	○	○
Fuel level float	●	●	●	●
Hydraulic oil level gauge	●	●	●	●
Ladder	●	●	●	●
Rear view camera	○	○	○	○
Rear view mirror(right & left side)	●	●	●	●
Side walk (cab side)	●	●	●	●
Swing parking brake	●	●	●	●
Tool box	●	●	●	●
Utility space	●	●	●	●
170 Ah batteries	●	●	●	●
2.3 mm thickness undercover	●	●	—	—
4.5 mm thickness undercover	—	—	●	●
9 080 kg counterweight	●	●	●	●

UNDERCARRIAGE				
Bolt-on sprocket	●	●	●	●
Full track guard	—	—	●	●
Hydraulic track adjuster	●	●	●	●
Idler track guard	●	●	—	—
Reinforced track links with pin seals	●	●	●	●
Travel motor covers	●	●	●	●
Travel parking brake	●	●	●	●
Track undercover	○	○	○	○
Upper and lower rollers	●	●	●	●
1 track guard (each side)	●	—	—	—
2 track guard (each side)	—	●	—	—
600 mm triple grouser shoes	●	●	●	●
600 mm double grouser shoes	○	○	○	○
750 mm shoe with standard track guard	○	○	—	—

Before using a machine with a satellite communication system, please make sure that the satellite communication system complies with local regulations, safety standards and legal requirements. If not so, please make modifications accordingly.

	ZX470-5G	ZX470LC-5G	ZX470H-5G	ZX470LCH-5G
FRONT ATTACHMENTS				
Attachment basic piping	○	○	○	○
Centralized lubrication system	●	●	●	●
Damage prevention plate and square bars	●	●	●	●
Dirt seal on all bucket pins	●	●	●	●
Flanged pin	●	●	●	●
Monolithically cast bucket link A	●	●	●	●
1.9 m ³ (ISO heaped) bucket	●	○	—	—
2.1 m ³ (ISO heaped) bucket	○	●	—	—
1.9 m ³ (ISO heaped) rock bucket (with dual type side shrouds)	—	—	●	●
7.0 m H-boom and 3.4 m H-arm	●	●	●	●
6.3 m BE-boom	○	○	○	○
8.2 m boom	—	○	—	—
2.5 m BE-arm	○	○	○	○
2.9 m BE-arm	○	○	○	○
3.9 m arm	○	○	—	—
4.9 m arm	○	○	—	—
Reinforced weld link A	—	—	○	○
Reinforced link B	—	—	○	○

MISCELLANEOUS				
Anti-slip steps and handrails	●	●	●	●
Lockable fuel refilling cap	●	●	●	●
Lockable machine covers	●	●	●	●
Onboard information controller	●	●	●	●
Standard tool kit	●	●	●	●
Theft deterrent system	●	●	●	●
Travel direction mark on track frame	●	●	●	●

OTHERS				
Global e-service	●	●	●	●

These specifications are subject to change without notice.

Illustrations and photos show the standard models, and may or may not include optional equipment, accessories, and all standard equipment with some differences in color and features.

Before use, read and understand the Operator's Manual for proper operation.