

# 7R SERIES

EFFICIENT. STRONG. RELIABLE.



**JOHN DEERE**

NOTHING RUNS LIKE A DEERE



# GIVING YOU WHAT MATTERS MOST

BREATH-taking PERFORMANCE, THE BEST CAB IN ITS CLASS, OPTIMUM COMFORT, LOW COST OF OPERATION AND MAXIMUM UPTIME.





## CONTENTS

Introduction .....	2
Overview .....	4
Tractor Efficiency .....	6
Engines.....	8
AutoPowr Transmission .....	10
e23 Transmission .....	12
More Traction, TLS and Tyres .....	14
Ballasting.....	16
CommandView III Cab.....	18
Intuitive Controls .....	20
Settings Manager .....	22
Driving Comfort (TLS, HCS, ActiveSeat) .....	24
LED Lighting.....	26
PTO, Hydraulics and Hitches .....	28
AutoTrac .....	30
Advanced Guidance and Precision Farming Solution ...	32
Manure Sensing .....	33
Connectivity Inside.....	34
Parts and Service .....	36
Non-agricultural Applications .....	38
Specifications .....	40
Editions & Connectivity Packages .....	44



# POWER TO DO MORE

High power density coupled with a high horsepower rating (up to 352 max engine hp with IPM) gives you speed and efficiency. Extensive hitch and PTO options also make the 7R Series tractors extremely versatile.

## PRECISION AGRICULTURE

The StarFire 6000 receiver comes with an improved signal range. For example SF3 at +/- 3 cm an in-season repeatability or the new John Deere Mobile RTK Signal that can also be operated via JDLink.

## UNRIVALLED FLUID EFFICIENCY

In DLG PowerMix\* Field and Transport tests the 7310R recorded the lowest total fluid consumption in its class.

## CONNECTIVITY INSIDE

Always be connected to your machines, your operators and your field data.

## 360° ILLUMINATION

22 LED lights providing optimum visibility.

## COMFORT

Quietest cab in the industry with 68 dB(A).



## RIDE & DRIVE QUALITY

Triple Link front axle Suspension (TLS) or Hydraulic Cab Suspension (HCS) in combination with ActiveSeat and ActiveCommand Steering (ACS) for an enjoyable ride.



## LOW RUNNING COSTS

Lifetime DPF (Diesel Particulate Filter) and long service intervals.

## ENGINE PERFORMANCE

The 6.8 l and 9.0 l engines give you fantastic power output at reduced operating costs.

## WHAT'S YOUR DRIVING STYLE?

100% mechanical or infinitely variable transmissions, with a range of driving modes, give you the power of choice.

## STRONG HYDRAULICS

Up to six rear and two front SCV's plus 85 l oil take-out capacity.

## POWER TO THE GROUND

The 2.15 m tyres provide excellent power transfer with a perfect machine weight split of 45:55.

## EASY TO USE

Generation 4 CommandCenter with 10 inch touchscreen.



MODEL	RATED ENGINE HORSEPOWER (97/68EC)	MAX. ENGINE HORSEPOWER WITH IPM (97/68 EC)	ENGINE TYPE	TRANSMISSION OPTIONS
7210R	210	249	6.8 l PVS	1) e23 2) AUTOPOWR
7230R	230	269	6.8 l PSS	1/2
7250R	250	290	6.8 l PSS	1/2
7270R	270	305	6.8 l PSS	1/2
7290R	290	332	9.0 l PSS	1/2
7310R	310	352	9.0 l PSS	1/2



# OUTSTANDING EFFICIENCY

How much power does a tractor actually deliver? Engine specification in the market can be deceiving. What matters is not the engine power or the decal on the bonnet, it's the power that can be transmitted to the ground or to the PTO.



## 7310R DLG POWERMIX TRANSPORT

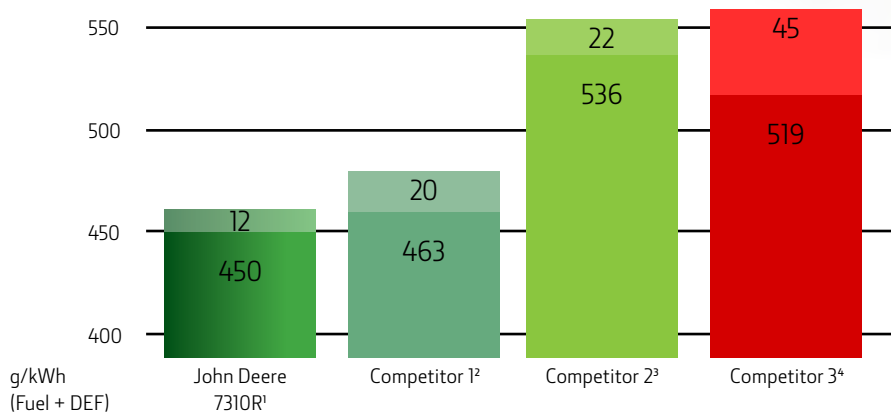

<sup>1</sup> DLG Powermixtest Nr.: 2014-0437; 10.2014; [www.dlg-test.de](http://www.dlg-test.de)

<sup>2</sup> DLG Prüfbericht Nr.: 6297; 2015; [www.dlg-test.de](http://www.dlg-test.de)

<sup>3</sup> Profi Test Results 04/2017, page 18

<sup>4</sup> DLG Powermixtest Nr.: 2015-854; 10.2015; [www.dlg-test.de](http://www.dlg-test.de)



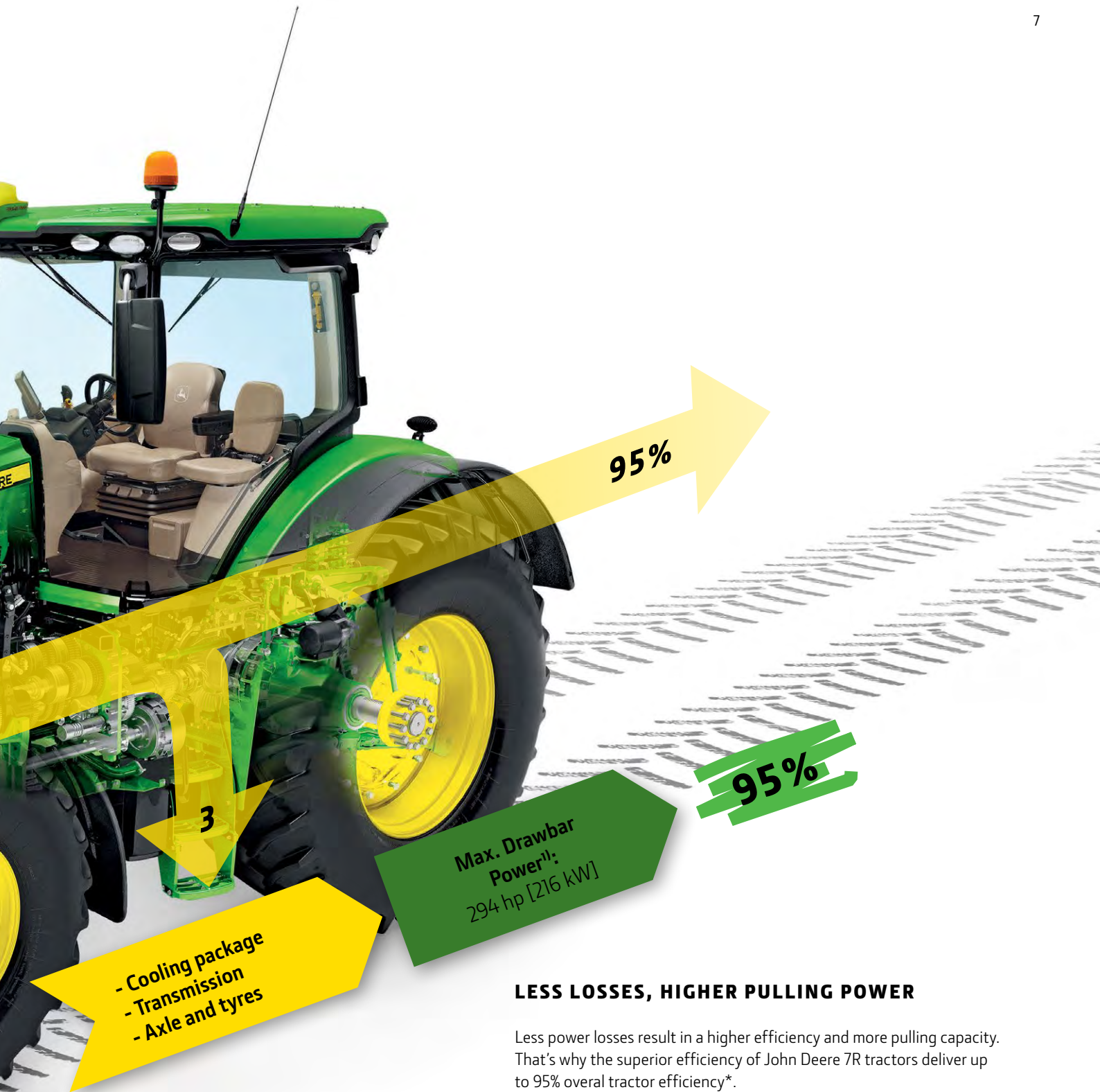

95%

95%

3

- Cooling package
- Transmission
- Axle and tyres

Max. Drawbar  
Power<sup>1)</sup>:  
294 hp [216 kW]

### LESS LOSSES, HIGHER PULLING POWER

Less power losses result in a higher efficiency and more pulling capacity. That's why the superior efficiency of John Deere 7R tractors deliver up to 95% overall tractor efficiency\*.

The compact and efficient cooling package (1) without compromise on cooling surface has an excellent airflow with no restrictions. The 6.8 l and 9.0 l engines offer superior torque and fuel economy under all conditions. You can count on the high transmission (2) efficiency of e23 PowerShift and AutoPowr. And finally, the axle design and wide tyres (3) up to 2.15 m diameter put more power to the ground.



# POWERFUL HEART

## GET THE JOB DONE IN ANY CONDITIONS

Exceptional performance starts with an exceptional engine and to build an exceptional engine you need a clear design strategy. John Deere 7R 6.8 l and 9.0 l engines have been designed and developed to deliver more torque and better agility with series turbo technology while meeting Stage IV standards.



### 6.8 L PVS & PSS ENGINES

The 6.8 l engine provides high performance horsepower and torque. The specially designed cylinder head for better cooling, steel pistons and a titanium turbo charger compressor wheel ensure increased uptime.

### 9.0 L PSS ENGINES

The 7290R and 7310R tractors are built with John Deere 9.0 l PSS engines, which have set new benchmarks for total fluid efficiency among high horsepower Stage IV-compliant tractors in the DLG Powermix test\*.

### 7310R PULLING PERFORMANCE THANKS TO WIDE CONSTANT POWER RANGES

The 9.0 l engine of the 7310R delivers the peak torque at the ideal rpm within wide constant power range to ensure tremendous pulling performance.

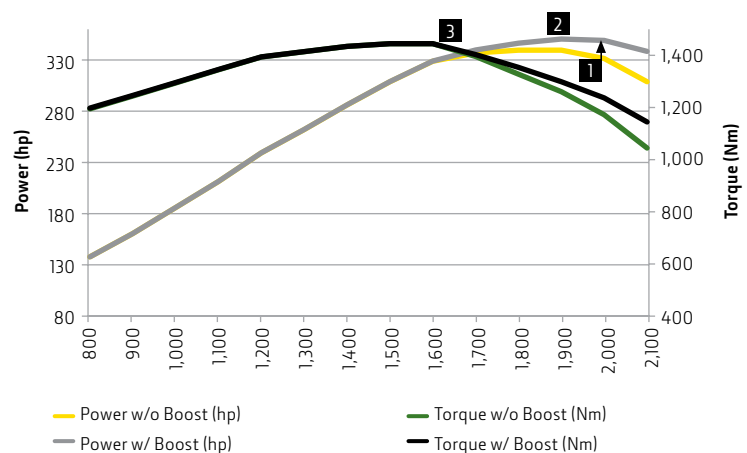

Intelligent Power Management (1) provides up to 30 additional hp for transport and PTO applications. Max. power with 352 hp @ 1,900 rpm (2) and max. torque of 1,452 Nm @ 1,600 rpm (3) ensure optimum response with low fuel consumption levels.

## SELECTIVE CATALYTIC REDUCTION (SCR)

Diesel exhaust fluid mixes with engine exhaust gases in the catalyst to reduce further NOx. The industry-leading DEF consumption is just 2-3% of diesel use.

## COOLED EXHAUST GAS RECIRCULATION (EGR)

Precise amounts of cooled exhaust gases are mixed with incoming fresh air, lowering combustion temperatures to lower NOx output while further reducing emissions.

## SERIES TURBOCHARGERS

The Dual Series Turbocharger with fixed geometry first stage and variable geometry second stage, deliver more low-speed torque and engine responsiveness to meet varying load requirements.

## AIR-TO-AIR AFTERCOOLING

Air-to-air after cooling lowers the intake manifold air temperature and provides more efficient cooling for greater engine power and reliability.

## ON THE ROAD

Contractors and farmers with a high level of road transport applications will benefit from the 7R's excellent fluids efficiency at transport. Thanks to the excellent power-to-weight ratio and the fast engine response the 7R will boost your transport business and increase your productivity.

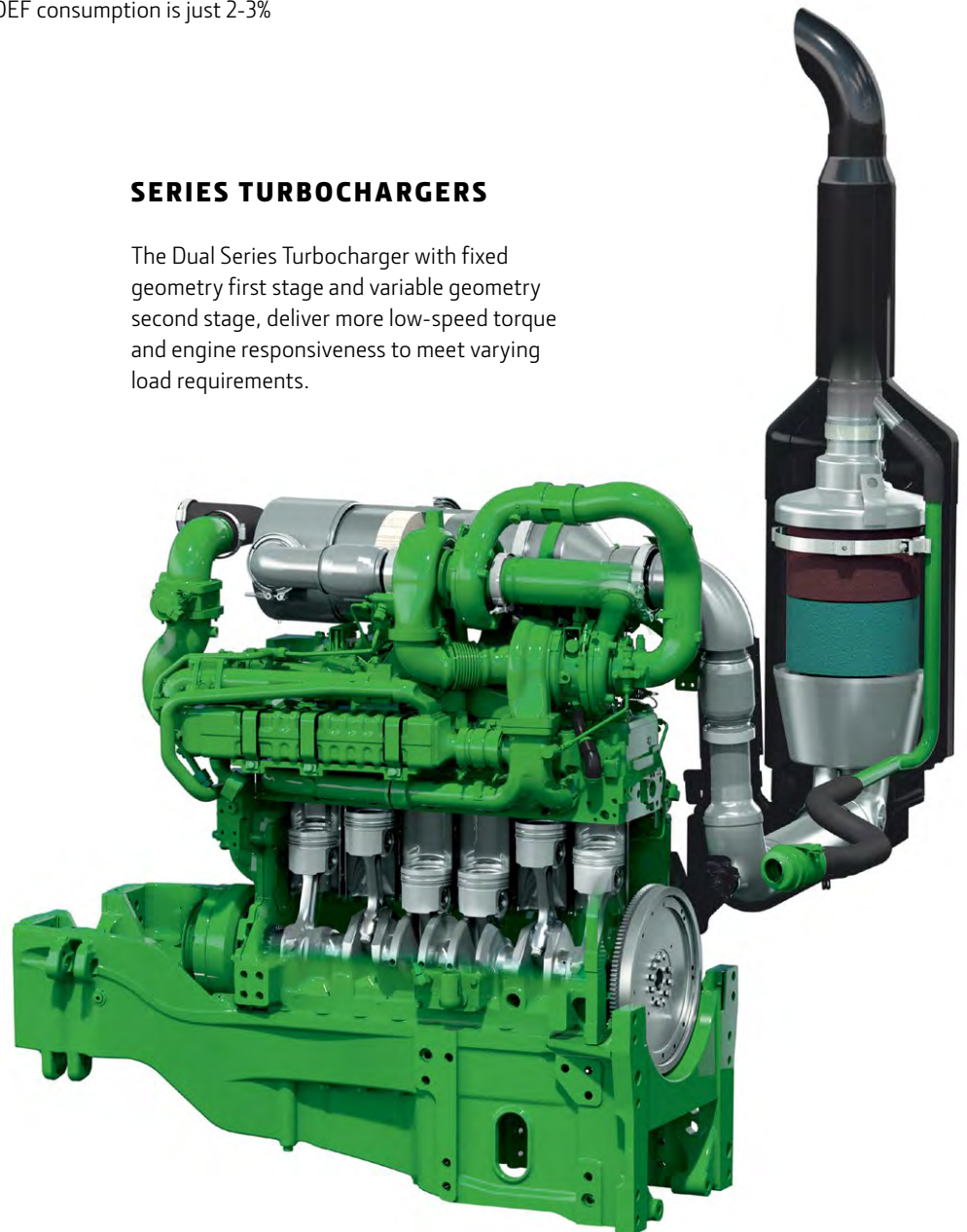

## CATALYSED EXHAUST FILTER WITH DOC/DPF

The diesel oxidation catalyst (DOC) and diesel particulate filter (DPF) remove particles down to 2.5  $\mu\text{m}$

## TRANSIENT ENGINE RESPONSE

The proven lifetime DPF in combination with the SCR system that has been specially developed by John Deere for our powerful engines, allows the engine to respond very quickly to changing loads.



# THE POWER OF CHOICE

The 7R Series tractors offer a range of transmission options to tackle the challenges of your operations: AutoPowr infinitely variable transmission and e23 PowerShift transmission.

## AUTOPOWR FOUR MODES

There are four different modes available to operate the AutoPowr: Full Auto, Custom, Manual and Pedal mode, which enables you to control ground speed separately from the engine.

## AUTOPOWR TRANSMISSION WITH AUTOCLUTCH

With the AutoClutch you can simply depress both brakes and the transmission ratios down to a stop from any ground speed without using the clutch pedal.

## AUTOPOWR: SMOOTH SHIFTING

AutoPowr lets you shift smoothly from start-up to maximum speed with a single lever and absolutely no clutching. Just select a specific speed and AutoPowr keeps it steady by automatically responding to changing load conditions.



## AUTOPOWR AUTOMATIC RESPONSE

AutoPowr lets you smoothly start-up, achieving maximum speed with absolutely no clutching. Top speed 40 km/h at 1,290 rpm and 50 km/h at 1,620 rpm for low transport cost.

## INFINITE SPEED ADJUSTMENT IN ALL SITUATIONS

AutoPowr delivers stepless and continuous power across an infinitely variable range of speeds, controlled by a single lever.

## AUTOPOWR INFINITELY VARIABLE TRANSMISSION

- 1 – Engine input shaft
- 2 – Hydrostatic Module
- 3 – Sun and Ring Unit Input
- 4 – Ring Gear
- 5 – Pinion Gears & Carrier
- 6 – M2 & M3 Clutches
- 7 – Output shaft with Mode 1, 2 & 3 Gears
- 8 – Pump Drive Gear
- 9 – Synchronizer Unit
- 10 – MFWD Clutch and Park Brake

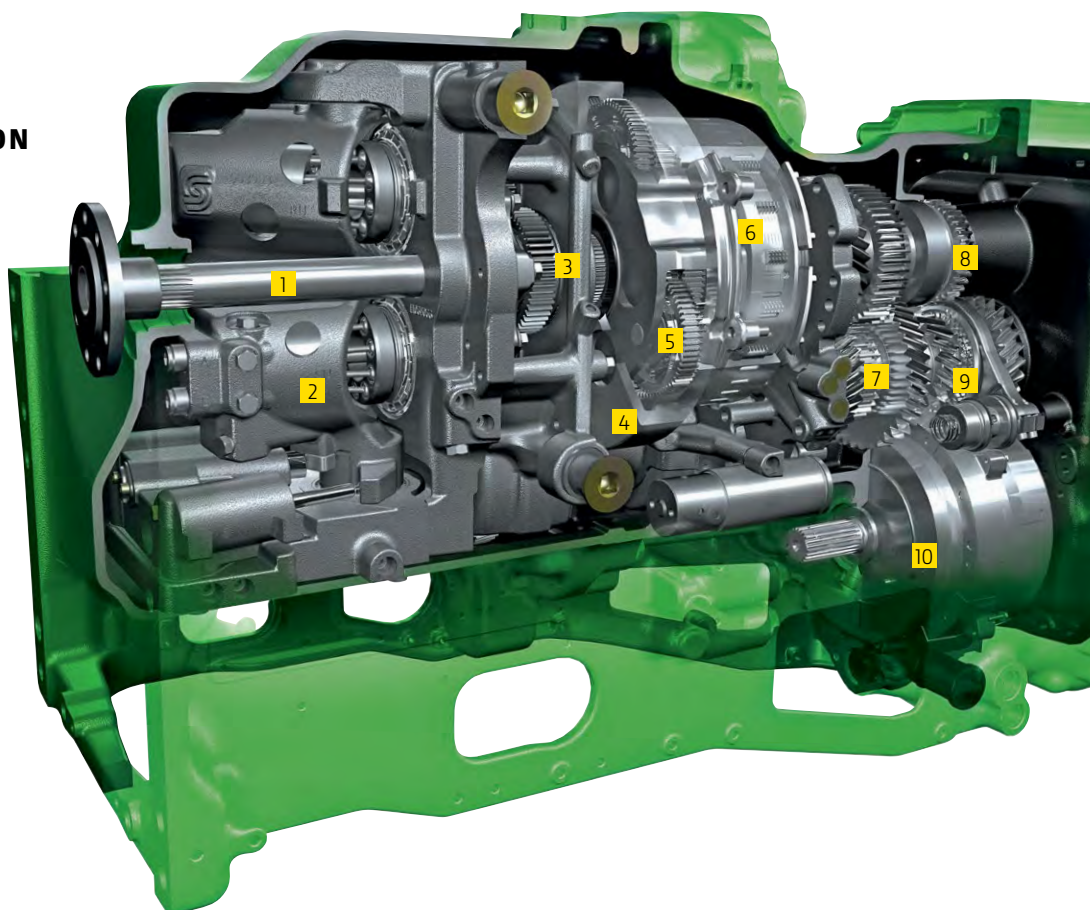

## AUTOPOWR: OUTSTANDING EFFICIENCY

The exclusive John Deere built AutoPowr transmission with three ranges ensures maximum mechanical power transfer in all speed ranges. With 55%-100% of mechanical power flow, the AutoPowr transmission boosts the efficiency of the tractor and gets more power to the ground. The reduced hydraulic part has another positive effect: a lower oil cooling requirement and better fuel efficiency.

## MECHANICAL PART OF THE POWER FLOW OF 7R AUTOPOWR

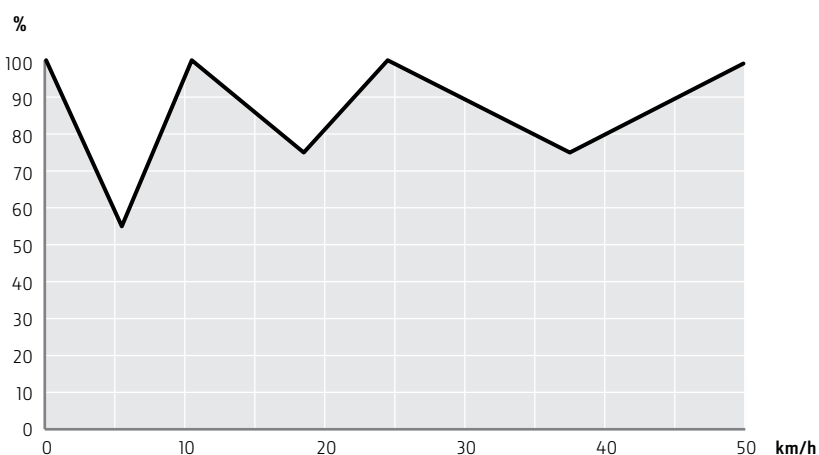



# EASY TO OPERATE

We offer you the flexibility to choose the right transmission to fit your needs: e23 transmission is engineered to deliver maximum power transfer for arable farming with road transport. Alternatively choose the intuitive functionality of AutoPowr infinitely variable transmission.

## e23 INDUSTRY LEADING TECHNOLOGY

The John Deere unique e23 full PowerShift transmission delivers the power 100% mechanically with its 23 forward and 11 reverse gears. The design of this sophisticated transmission reduces the losses to a minimum and ensures the most efficient way of power transfer through the drive train of a tractor. This enables the operator to get more power to the ground, covering more hectares and reducing the total fuel consumption per hour.

## EVEN GEAR SPACING OF e23 TRANSMISSION

The gears are evenly spaced in e23 transmission, with lots of gears in the main working range for high efficiency.



### e23 TRANSMISSION

- 1 – Engine Input Shaft
- 2 – Low Clutch
- 3 – High Clutch
- 4 – Reverse Clutch
- 5 – Speed Clutches S1 & S2
- 6 – Speed Clutches S3 & S4
- 7 – Accumulator
- 8 – Range Clutch R1
- 9 – Range Clutches R2 & R3
- 10 – Hydraulic Pump Drive Gear
- 11 – Park Brake
- 12 – MFWD Clutch
- 13 – Rear Differential Output

### e23 TRANSMISSION WITH AUTOCLUTCH

e23 combines all the benefits of a mechanical transmission with the ease of use of an AutoPowr. With the AutoClutch you can simply depress both brakes and the transmission shifts down to a stop from any ground speed.

### e23 TRANSMISSION WITH EFFICIENCY MANAGER

Efficiency Manager allows the operator to preset the working speed and helps to save fuel by keeping the engine rpm at an optimum speed by automatically shifting up and throttling back.

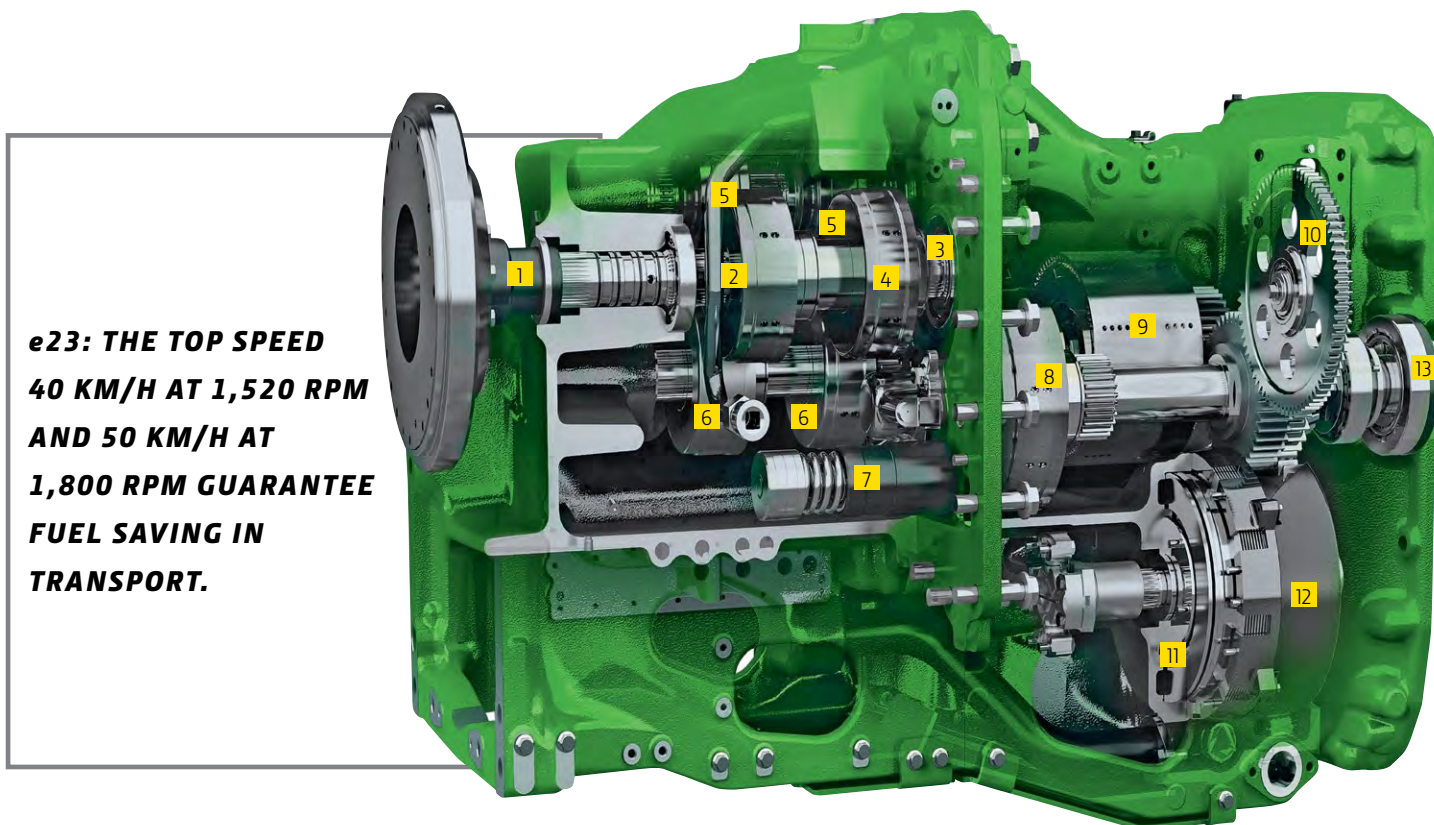

**e23: THE TOP SPEED  
40 KM/H AT 1,520 RPM  
AND 50 KM/H AT  
1,800 RPM GUARANTEE  
FUEL SAVING IN  
TRANSPORT.**

### TOP FIELD PERFORMANCE

Ten gears in the main working range from 5-16 km/h provide the best gear for the most demanding pulling application, resulting in highest field performance.

### TEN FULLY POWERSHIFTABLE GEARS IN THE MAIN WORKING RANGE

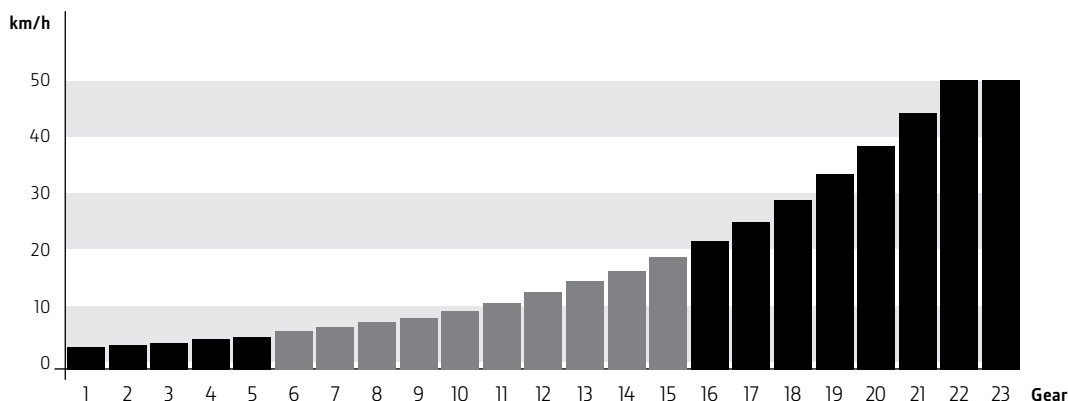



## **FASTER TURNS, INCREASED FIELD SPEED**

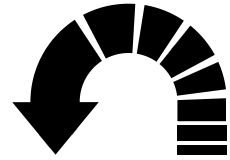

The structural chassis of the 7R Series has been designed for unprecedented power density. With a robust chassis, TLS Plus front axle providing extra drawbar pull, and a long wheelbase for additional pulling power and stability, John Deere 7R Series tractors deliver increased productivity with high payloads, even in tough conditions.







**WHEELBASE** 2,925 mm (A)

**OVERALL LENGTH** (B) Without front weights  
5,520 mm (7210R, 7230R)  
5,540 mm (7250R, 7290R, 7310R)

**TOTAL HEIGHT** (C)  
3,630 mm (Group 49 tyres & beacon light)

**WIDTH** (D)  
2,602 mm (with 710/70R42 tyres, tread setting of 1,793 mm)

## TYRES

John Deere offers a variety of tyre options for a wide range of field and transport applications. Select 2.15 m diameter rear tyres (7250R models and above) for better power transfer and higher ground clearance. You will also get sufficient traction with less ballast, reducing soil compaction.

## PERFECTLY BALANCED

7R Series tractors are designed with a perfect 45:55 weight split. Wide ballasting options are available if required and can be easily installed and removed due to the self-centring guide lugs.





# ADD HEAVY BALLAST – WITH A LIGHT TOUCH

The new EZ Ballast exclusively enables optimal ballasting of the tractor – especially beneficial to farmers and contractors who frequently need to switch between field and road applications. You can add or remove the 1.7 tonne weight in seconds, at the touch of a button without needing to step down from the cab.

**AGRITECHNICA SILVER  
MEDAL – JOHN DEERE  
EZ BALLAST.**

## EZ BALLAST

- A 1.7 tonne ballast weight is attached to the bottom of the tractor in seconds
- Keep the recommended front and rear weight split of the tractor
- Front/rear hitches remain free for other implements
- Fast, safe and easy operation from the tractor cab
- Releasing the ballast will save transport fuel cost and increase the payload on the road
- Adding the correct amount of ballast will increase the productivity in the field

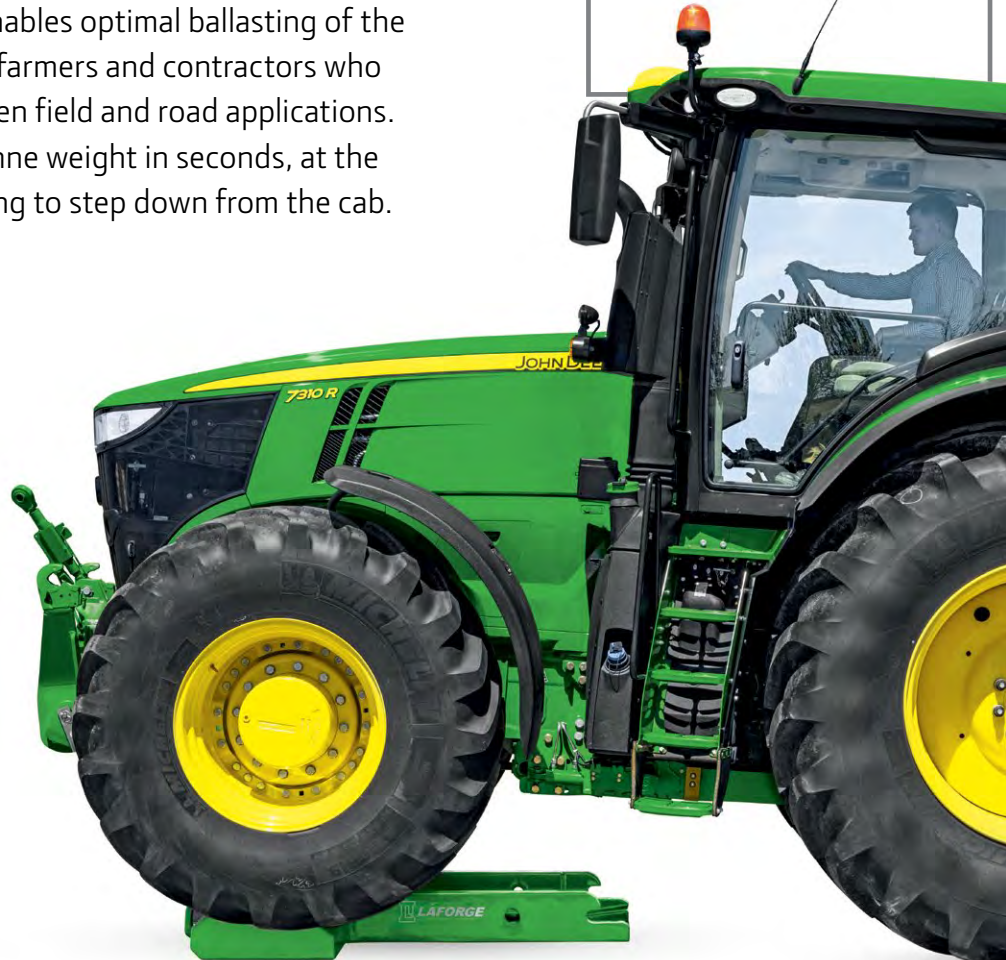

## DRIVE OVER THE WEIGHT

There's no need to step down from the cab.



## PICK UP THE WEIGHT

Simply use the dedicated control panel and the ballast is raised to the undercarriage (connected to existing Power Beyond system). A safety device will ensure unfailing locking.



## DRIVE OFF

Releasing the ballast is just as simple and will save transport fuel costs.

# BALLASTING FLEXIBILITY

With the ever-increasing costs of fuel, correct weight distribution and flexible ballasting play an increasingly important role in driving productivity and performance. John Deere 7R Series tractors offer several options to provide the optimum balance.



## FRONT SUITCASE WEIGHTS (50 KG)

These weights can easily be mounted/dismounted to the front weight support. They support an optimised weight distribution between the rear and front axle, as the amount of weights being used can be quickly adapted to current application requirements.

## REAR WHEEL WEIGHTS

Rear wheel weights enable correct ballasting of the rear axle for improved traction. They can be mounted on the outside of wheels. With cast wheels they can also be mounted on the inside (except for 900 kg). Available with 72 kg, 205 kg, 625 kg (inner only) and the all-new 900 kg.

## PICK-UP WEIGHTS

Pick-up weights help you get the perfect balance and improve the tractive performance of your 7R. Available in 900 kg, 1,150 kg, 1,500 kg and 1,800 kg versions, they can be mounted to the front hitch or the front weight support (900 kg, 1,150 kg only).





# ULTIMATE CONTROL

When you climb into the CommandView III cab the first thing you notice is the space you have and the premium fit and finish quality. The sensationally low 68 dB(A) makes for a more relaxed day.

Visibility is also better than ever, especially when you rotate the seat 40 degrees for a nearly unobstructed view of your attachments. All of the key tractor functions such as the throttle, transmission speed, SCVs and PTO are at your fingertips on the smartly configured CommandARM.



## ACS – REDUCED STEERING EFFORT

The optional ActiveCommand Steering reduces steering effort to prevent operator fatigue:

### – DYNAMIC ROAD WHEEL OFFSET CONTROL

keeps your tractor on track with minimal effort. It automatically adjusts the road wheel angle based on the lateral acceleration of the tractor.

### – VARIABLE RATIO STEERING

provides light, agile steering at slower speeds, and heavier steering for higher speeds. ACS automatically reduces to 3.5 lock to lock steering wheel turns for quick headland turns.

### – FULL ELECTRONIC STEERING CONTROL

removes all the drawbacks of a conventional steering column-to-wheel setup. It reduces vibration significantly, and eliminates free play completely.







### WIDE ANGLE MIRRORS

The wide angle mirrors with optional power telescoping provide a wide field of vision. They are also heated for greater visibility even in cold or foggy conditions.

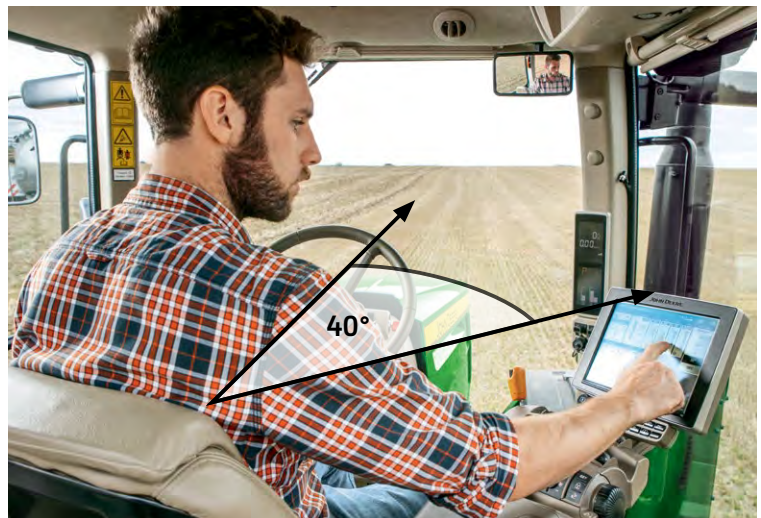

### 40 DEGREE SWIVEL SEAT

Visibility and comfort is better than ever, especially when you rotate the seat 40 degrees for a nearly unobstructed view of your attachments. You will feel the difference after a day of work.



# CONTROLS AS INTUITIVE AS A SMARTPHONE

The 7R Series makes sophisticated agricultural technology easy to operate. Everything is within easy reach on the CommandARM control stack and clearly viewable on the Generation 4 CommandCenter.

## EASE OF USE

Navigation is made easy with logical menus and a comprehensive shortcut bar. With Quick Line you can now record an AB line with just one button press.

## TAILOR YOUR 7R TO YOUR NEEDS

Choose the 4100 or 4600 CommandCenter. Choose CommandCenter AutoTrac or CommandCenter Premium activation.

## ISOBUS AEF CERTIFIED

The Generation 4 CommandCenter is AEF ISOBUS compliant, you can control your ISOBUS-ready implement through Universal Terminal (UT) and run automatic section control through Task Controller (TC-SC, TC-BAS) – depending on the AEF certification level of the implement.

## EVEN FASTER ACCESS TO ADVANCED FUNCTIONS

The CommandCenter functions just like a tablet with touch-screens: navigating through the options is simplified via menus, shortcuts and with context-sensitive help. And you can run our field proven mainstream AMS solutions.

## EASY SCV CONTROL

On the CommandARM, the selective control valve levers and couplers are colour-coded to simplify recognition. For convenience, all SCVs can be operated via easy to reach SCV control levers. All SCV levers can be easily reconfigured and stored individually for each application with the new Settings Manager.

## EXTENDED MONITOR

By adding the new Extended Monitor to your tractor you can easily move functionalities from one monitor to the other in order to maximise productivity by monitoring all your applications at once. e.g. Vehicle Control on your primary display and Precision Ag Applications on the Extended Monitor.



## DOCUMENTATION MADE EASY

The 4600 CommandCenter is connected to the Operations Center on MyJohnDeere.com through Wireless Data Transfer. You can conveniently send setup files from office to field and applied maps and totals from field to office.

## VIRTUALLY IN THE CAB

You or your John Deere dealer can remotely log on to the Generation 4 CommandCenter to assist operators with machine and ISOBUS implement setup and operation. In addition, on-screen help files enable operators to get familiar with all functions.



## FIELD-PROVEN AUTOTRAC

Fit a StarFire 6000 receiver and an AutoTrac activation and you're ready for hands-free steering. Choose between three accuracy levels: SF1: +/- 15 cm; SF3: +/- 3 cm delivering in-season repeatability; RTK: +/- 2.5 cm delivering long term repeatability.

- 1 – Transmission shift lever with thumb wheel for speed adjustment
- 2 – SCV control lever lock / ISOBUS shortcut button
- 3 – Rear hitch control lever
- 4 – SCV control levers
- 5 – Set speed 1&2
- 6 – AutoTrac resume button and 4 iTEC sequence buttons
- 7 – Hand throttle, ECO-function, foot pedal lock button, FieldCruise ON/OFF button
- 8 – Differential lock & mechanical front-wheel drive (MFWD)
- 9 – Generation 4 CommandCenter Featuring a 7 or 10 inch touchscreen, the Gen 4 CommandCenter is your state-of-the-art interface with the tractor and enables you to run field-proven AMS solutions such as AutoTrac
- 10 – Shortcut keys/buttons for fast operator access to specific functions
- 11 – Joystick with lock button  
Joystick mode: configurable with tractor functions to operate front and rear SCVs and/or front hitch  
Loader mode: operate front loader
- 12 – Climate, radio and lighting controls
- 13 – PTO control levers
- 14 – Secondary brake lever



# SETTINGS MANAGER TAILOR IT TO YOUR NEEDS

All the daily tasks an operator needs to manage during his job requires different functions and levers to be operated at the same time. With the new generation of 7R Series tractors, almost everything could be reconfigured on the CommandARM to meet the desires and requirements of the operator and his application.

Instead of SCV "1" you would like to operate the front hitch next to the rear hitch lever – no problem! Entering the Control Setup enables you to reconfigure all hydraulic functions on the joystick or on the SCV levers. For even more operator comfort ISOBUS driven implements can be operated via the push buttons on the joystick. For the ultimate level of reconfigurability,

easily set functions like loader auxiliaries, AutoTrac activation, iTEC sequences and gear-shifting to the joystick push buttons or SCVs, whereas the SCVs, front and rear hitches can be set to the axes of the joystick. And the best: you can set up and recall all your settings individually per implement in the Settings Manager.



- 1** – Axles available for:
- SCV control
  - Front/Rear hitch
  - Front loader operation

- 2** – Rocker switch available for:
- SCV control
  - Front/Rear hitch
  - Front loader operation

- 3** – Push buttons 5-9 available for:
- Front loader auxiliary functions
  - AutoTrac assisted steering system
  - iTEC headland management sequences 1-4
  - ISOBUS push button functions
  - Gear shift (e23 only)





### CONTROL SETUP FOR ISOBUS FUNCTIONS ON ELECTRICAL JOYSTICK

For using ISOBUS push functions on the electrical joystick, the operator can select the buttons of the electrical joystick in the CommanCenter.

### COMMANDARM – CONTROLS SETUP IN THE COMMANDCENTER

The operator can choose from different functions for the CommandARM controls: iTEC sequences 1-4, SCV control or front/rear hitch.



### DEFAULTS FUNCTION IN THE CONTROL SETUP

The operator also has the possibility to set all reconfigured controls (custom) for the paddle pods and the electrical joystick back to the factory settings (default) in the settings.



### SETTINGS MANAGER

Reducing the set up time for all your different applications the Settings Manager allows you to save all your machine settings, for example; engine, SCVs and rear hitch as well as configuration settings for the electrical joystick. This allows you to instantly recall your individual settings for implements or operators.



# A SMOOTH RIDE

IF YOUR BUSINESS INVOLVES TOWING VERY LARGE LOADS, THE 7R SERIES IS THE IDEAL TRACTOR.

The Triple-Link Suspension Plus (TLS Plus) increases both transport and field productivity with superior stability, ride, and comfort. The John Deere ActiveSeat or the adaptive Hydraulic Cab Suspension (HCS plus) allows the operator to increase productivity and decrease the effects of fatigue.



## ADAPTIVE HYDRAULIC CAB SUSPENSION (HCS PLUS) – A MORE RELAXED DAY

The adaptive hydropneumatic cab suspension plus (HCS plus) allows the operator to increase productivity and decrease the effects of fatigue.

Regardless of the application, the adaptive hydraulic-pneumatic cab suspension system by John Deere is proactive, permanently active and cushions the operator in a variety of applications.

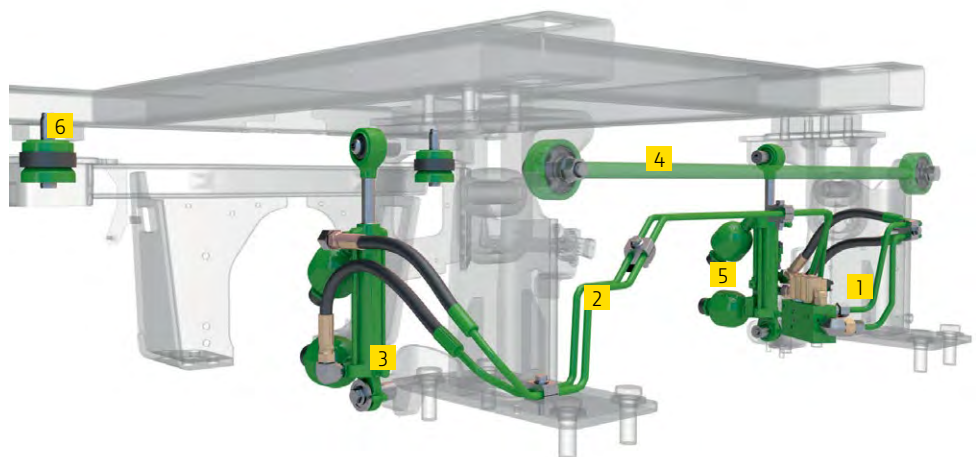

- 1 – Cab Levelling Control Valve
- 2 – Cab Levelling Control Valve Lines
- 3 – Hydraulic Cylinder
- 4 – Panhard Rod
- 5 – Accumulator
- 6 – Cab Mount



### TRIPLE-LINK SUSPENSION PLUS

Our TLS integrated self-levelling front suspension puts maximum power to the ground. Triple-Link Suspension Plus (TLS Plus) is a fully integrated, self-levelling front suspension system. It further improves traction by keeping the front wheels in contact with the ground and lets you increase field speeds. TLS+ is available with a hydraulic differential lock for serious pulling power and wet-disc brakes. Triple-Link Suspension Plus allows you to select front axle settings for different uses.

- 1 – Suspension cylinder
- 2 – TLS Dampening Valve with suspension accumulators
- 3 – Tie Rod
- 4 – Differential housing

### ACTIVE SEAT

The John Deere ActiveSeat utilises electro-hydraulic technology in combination with air suspension, providing the operator with enhanced ride-quality over standard air-suspension seats. Operator movements are monitored in order to reduce vertical movement. An ActiveSeat suspension can isolate the operator from up to 90% of vertical movements typically seen in tractor applications.

- 1 – Scissor Suspension
- 2 – Air Reservoir
- 3 – Accelerometer
- 4 – ActiveSeat Actuator
- 5 – Air Compressor & Air Spring
- 6 – Lateral Shock







**FOR YOUR CONVENIENCE, ALL  
LIGHTING IS EASILY CONTROLLED  
VIA THE COMMANDCENTER.**

### **BASE LIGHTING**

- 1 Six front grille-mounted halogen lights
- 2 Twelve cab roof-mounted halogen lights
- 3 Two rear fender-mounted lights
- 4 Two rear turn signal and brake/tail lights
- 5 Two front corner lights & two belt-line lights
- 6 LH rotary beacon light

### **PREMIUM LIGHTING**

All halogen lights will be replaced by LED lights (except for two low beam road lights)

### **OPTIONAL**

- 7 Two extremity lights
- 8 Two loader/driving lights
- 9 RH Rotary beacon light



# YOU'VE NEVER SEEN ANYTHING LIKE IT!

## UP TO 26 LIGHTS PROVIDE 360° VISIBILITY

The LED option provides 40% greater coverage to the side-view and 10% greater rear-view coverage, compared to the standard halogen lighting. The LED lighting on John Deere 7R Series tractors provides high quality white illumination for easier visibility and contrast. There are 22 LED lights providing 360° visibility.

Result: night becomes day, putting less strain on the eyes.

LEDs are virtually indestructible, with a minimum 10,000 hours life expectancy and high resistance to vibration and extreme temperature.



**WORKING LIGHTS WISELY INTEGRATED INTO THE FRONT, REAR AND SIDES OF THE ROOFLINE TO PREVENT POSSIBLE DAMAGE FROM HANGING BRANCHES.**



# ULTIMATE PULLING POWER AND LIFT

Massive power combines with a wide range of easy to use hitch and PTO options to give you unprecedented versatility. Integrated front hitch and PTO make the 7R Series an especially impressive performer in all front-implement applications, with two SCVs, ISOBUS and double-acting cylinders.



## EFFORTLESS HITCH CONTROL

Hitch controls are located in the CommandCenter: Electronic sensors instantaneously relay information to the control module for fast and accurate corrections. Controls can also be accessed on the rear fender extensions.

## REAR PTO

7R Series tractors have several PTO options, such as 540E / 1000 / 1000E PTO, available to provide the versatility and flexibility needed to satisfy all implement demands at this power level.

## INDEPENDENT REAR SELECTIVE CONTROL VALVES

7R Series tractors offer four, five or six rear electro-hydraulic SCVs. Each has its own controller, making field installation of extra SCVs easier.

## FRONT HITCH AND SCVS

The front hitch has a maximum lift capacity at the hitch couplers of 5200 kg. One or two independent front SCVs are available, with adjustable flow rates.



## MORE ATTACHABILITY

The front and rear hitch are iTEC-compatible for total implement management. Electronic sensors relay information to the hitch control module for instantaneous and accurate corrections.

## REAR HITCH-LIFT CAPACITY

Designed for strength and versatility, the 3-point hitch has a lift capacity of up to 10.2 tonnes maximum lift capacity on selected models.



## DRAWBAR HITCHES

For a robust connection to pulled implements a drawbar can be equipped to the 7R Series tractors. An adjustable drawbar with a category 3 pin (38 mm) fulfils the needs of most implements. The optionally available category 3 heavy-duty drawbar allows a vertical load up to 4,500 kg.

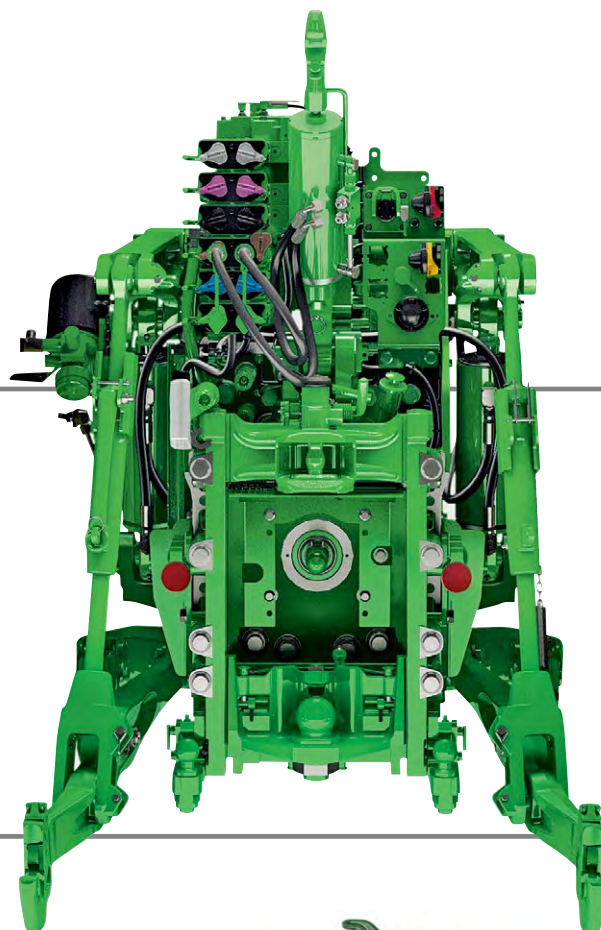

## REAR HITCH OPTIONS

7R Series tractors offer a variety of rear hitch options to complement application needs: standard lift capacity for lighter implement applications as well as higher lift capacity for heavier implements.



### BALL-TYPE AND PITON FIX HITCHES

These hitches are height adjustable, perfect for trailer operation and many other implement applications. When used in low position, they provide optimum traction and driving dynamics of tractor/trailer combinations.



### AUTOMATIC WAGON HITCH

Makes attaching implements much more convenient compared to manual wagon hitches.



### FORCED STEERING SYSTEM

For even higher versatility our hitches can be equipped additionally with a forced steering system to operate large trailers with steering axles.





# MAKE THE MOST OF YOUR DAY

## AUTOTRAC

AutoTrac hands-free steering adds more comfort: It reliably steers your tractor from day to night, through dust or on hilly terrain. This prevents costly overlaps or gaps and enables every operator to run at peak performance. With the Generation 4 CommandCenter and a StarFire receiver, all you need is a CommandCenter AutoTrac activation and you're ready to start. Using AutoTrac you can expect up to 8\* percent input savings and up to 14\*\* percent productivity increase.



### The new StarFire 6000 receiver

Fascinating with yet a new level of accuracy, signal stability and repeatability:

#### **RTK WITH 2.5 CM**

Pass-to-pass accuracy, featuring long-term repeatability including 14 days RTK Extend if you lose line of sight or mobile network.

#### **SF3 ENABLING 3 CM**

Pass-to-pass accuracy and 9-month in-season-repeatability.

#### **IMPROVED SF1 WITH 15 CM**

Pass-to-pass accuracy, free of charge

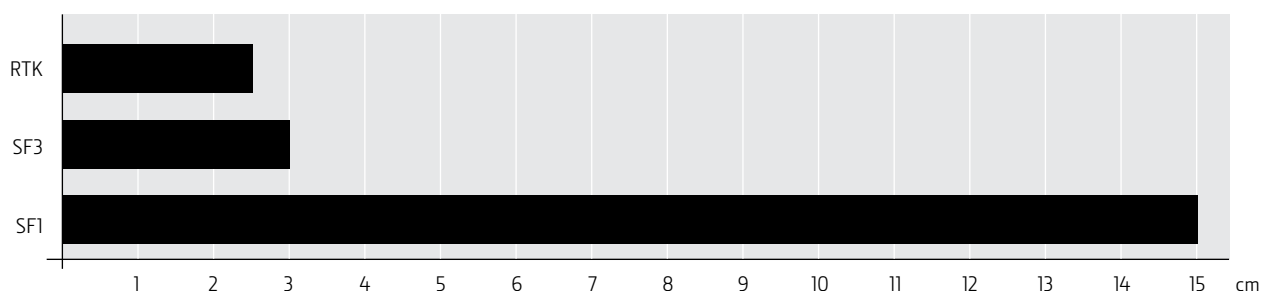



## COMMANDCENTER 4600 DISPLAY

With the CommandCenter 4600 Display, you can easily upgrade to the CommandCenter Premium Activation, adding section control and documentation functionality at any time. This configuration will also allow you to leverage the benefits of wireless data transfer and therefore automatic data exchange with the Operations Center on MyJohnDeere.com.



## NEW PRECISION

The John Deere Mobile RTK Signal can be operated via the machine's in base JDLink system. Saving you the extra cost for an RTK Modem and the annual cost for a SIM-card with data plan. (Check country availability).



# PERFECT RESULTS

## ADVANCED GUIDANCE AND PRECISION FARMING SOLUTIONS

Take the next step in precision productivity with iTEC Pro enhancing AutoTrac with automated headland turns. And spray, spread and seed with perfection even on wedged-shaped fields using John Deere Section Control.



### iTEC PRO

Intelligent Total Equipment Control integrates AutoTrac automatic steering and implement management systems to automatically control e.g. speed, hitch, hydraulics, PTO, four-wheel drive engagement etc. This allows hands-free turns, while reducing soil compaction. For picture-perfect headlands and consistent crop growth.

### JOHN DEERE SECTION CONTROL

John Deere Section Control minimises skips and overlaps automatically on-the-go. As a result, you can do a better job faster – and save money on fertiliser, chemicals and seed. This ISOBUS standard solution is available for sprayers, seeders/planters and spreaders.





# JOHN DEERE MANURE SENSING

## NUTRIENTS FOR YOUR BUSINESS

Manure is a high quality but extremely heterogeneous fertiliser. Nutrient levels vary significantly up to factor 25 – even within one tank load. John Deere Manure Sensing enables on-the-go analysis of nutrients in manure and thereby close to the applicator. An NIR (Near Infrared) sensor fitted to the slurry tanker measures N, P, K,  $\text{NH}_4$  and dry matter with more than 4,000 measurements per second. With a John Deere tractor, the sensor can directly command speed adjustments to increase or lower application rates based on your desired nutrient target level and even leveraging a prescription map. This enables you to maximise yields and meet legal requirements while cutting costs on mineral fertiliser.

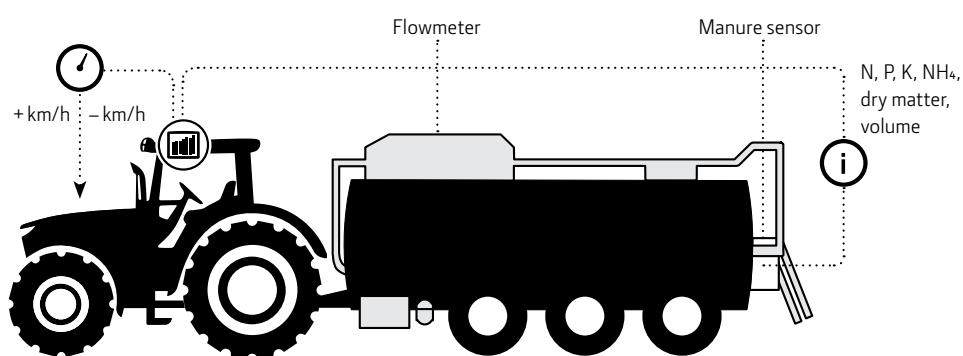

### SITE-SPECIFIC APPLICATION

Target rate based on kg/ha N, P, K,  $\text{NH}_4$  or volume.  
Limit rate for second ingredient.

### TRACTOR-IMPLEMENT AUTOMATION

Automatic speed adjustment with John Deere tractors.  
Manual speed adjustment with non-John Deere tractors.

### SITE SPECIFIC DOCUMENTATION

Applied volume.  
Applied amount of nutrients.

### EASY ACCESS TO COLLECTED DATA

Nutrient maps accessible in the Operations Center on MyJohnDeere.com



# YOUR GATEWAY TO BETTER BUSINESS DECISIONS

You're managing a complex enterprise. That's why optimising the overall business depends on being well connected to your ongoing operations.

The Operations Center on our Ag web portal MyJohnDeere.com makes it simple. It connects you to your machines, your operators and your fields

from one central location. It also allows you to exchange information seamlessly with your John Deere dealer, your contractor or other trusted partners.

## JDLINK

JDLink Access shows you where your machines are, what they're doing and how they perform and you or your dealer can remotely assist your operators with machine setup and operation leveraging Remote Display Access. JDLink Connect additionally includes Wireless Data Transfer for seamless data exchange between your machine and the office.



	Tuesday 17	Wednesday 18	Thursday 19	Friday 20	Saturday 21
	Harvest Transport 4	Seeding Transport 987 ac 3	Harvest Transport 1	Scouting Seeding Transport 18.37 ha 1	Mowing Transport 1 3
HARVEST	SEEDING	HARVEST	SCOUTING	MOWING	
My Ultra Field	987 ac	Farm 1	My Ultra Field	Farm 1	
Farm 1	My Ultra Field	Farm 1	Farm 1	Farm 1	
Farm 1	My Ultra Field	Farm 1	Farm 1	Farm 1	
Farm 1	My Ultra Field	Farm 1	Farm 1	Farm 1	
TRANSPORT	TRANSPORT	TRANSPORT	TRANSPORT	TRANSPORT	
My Ultra Field	Farm 1	My Ultra Field	My Ultra Field	My Ultra Field	
My Ultra Field	Farm 1	My Ultra Field	My Ultra Field	My Ultra Field	

## JOB MANAGEMENT MADE EASY

Eliminate paperwork and endless phone calls during job planning, execution and reporting. With MyJobConnect you can assign clearly defined tasks to your operators on-the-go, utilising the MyJobsManager App. Your operators can view the work orders in real-time and execute accordingly utilising the MyJobs App on their mobile device. And once the job is done you have instantly accurate and complete data at hand for quicker job reporting and professional invoicing.

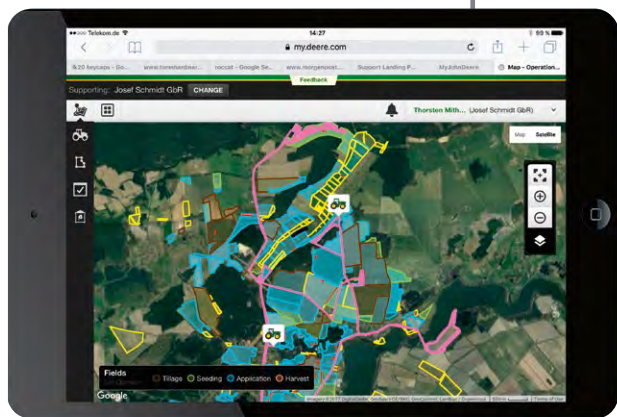

## OPERATIONS CENTER

Go to the Operations Center to allocate exact field locations for the next jobs, track the work progress of your machines, easily assign work orders to your operators, view as-applied maps automatically sent from the field as well as create, analyse and share application reports with trusted partners and customers.

## CONNECTIVITY INSIDE PACKAGES

Your 7R tractor comes pre-equipped with a suite of smart technologies that help you increase profitability, comfort and uptime while reducing cost of operation\*:

- 4600 CommandCenter with CommandCenter AutoTrac or CommandCenter Premium Activation
- 5-year free JDLink subscription
- Access to the Operations Center on MyJohnDeere.com
- Tractor-Implement Automation
- MyJobConnect or MyJobConnect Premium

All the above plus a FarmSight dealer Service Package to train and support you with the use of these technologies is what we have to offer for those that decide to go for Connectivity Inside. (Please see page 45 for more details)

\* Elements of the Connectivity Packages are a limited promotional offer and include time based subscriptions.

## INTELLIGENT AG NAVIGATION & FLEET LOGISTICS

Getting the right equipment at the right time to the right place is key to maximise efficiency and timeliness of multi machine operations. MyJobConnect Premium extends MyJobConnect to a true mixed fleet logistics solution. It features fleet overview, turn-by-turn navigation based on a comprehensive field road database including estimated arrival times for vehicles at the predefined destination. For example, setting up navigation to the lead machine enables silage trailers to take the fastest and safest way to the forage harvester and updates the tour of all fleet members as soon as the machine is moving to the next field.

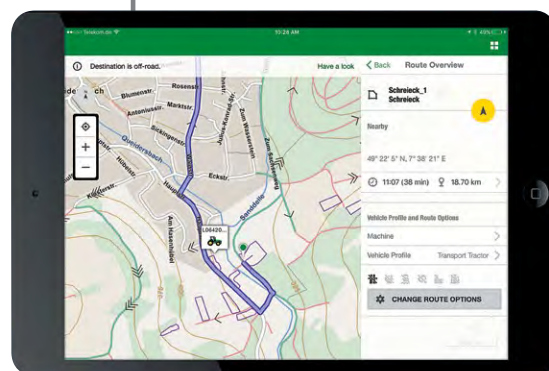



# ALWAYS THERE FOR YOU. GUARANTEED

## EXPERIENCE THE POWERGARD FEELING

When it comes to protecting your machines and your business, peace of mind is not something that somehow happens if you're lucky. Peace of mind is a choice that you can make. PowerGard agreements protect you against unexpected repair costs and keep your maintenance on track with genuine parts. Three fixed rate packages provide increasingly comprehensive levels of coverage to keep your machine running at peak performance with steady uptime.

### Financing

Our goal is simple: Empower you to purchase what you need to take your business to the next level. This includes financing your PowerGard agreements at competitive rates, with flexible payments.\*

### PowerGard Maintenance

Preventative maintenance work – it's essential for keeping equipment in good working order based on factory recommended intervals.

### PowerGard Protection

Base level of protection that covers unusual events that can lead to costly repairs, less a deductible for each repair.

### PowerGard Protection Plus

The ultimate in protection – the total peace of mind package that covers electrical, cooling, hydraulics and more.

\* Financing for PowerGard Maintenance is currently only available with participating dealers. Country regulations apply.



## FARMSIGHT – PROFIT FROM INSIGHT

John Deere FarmSight dealer services support you in the daily use of your 7R tractor with the latest AMS technology. Your 7R is equipped with JDLink and Service ADVISOR Remote as standard. You can participate for a 1 year test period of JDLink Access.

### Uptime

Remote monitoring and service support designed to maximise machine uptime

### Performance

Monitoring of key performance indicators of individual machines to maximise productivity and efficiency.

### Logistics

Monitoring of multiple machines to optimise the efficiency of larger fleets.

### Agronomics

Help and advice for making more informed business decisions to improve productivity and profitability.

### INVESTING IN YOUR 7R PAYS DIVIDENDS

Personalise your 7R with genuine John Deere attachments. They will support you in making each working day more efficient, more convenient and less fatiguing. Designed and engineered by John Deere, you can be sure they'll fit properly and are built to last.



#### ADD MORE

More performance and productivity with front and rear ballasting solutions.

More versatility with genuine hitch solutions and hydraulic options.

More comfort and convenience with a wide range of mounting brackets, a refrigerator, and front and rear fenders which suit perfectly to your tyres.



#### GENUINE FOR A REASON

- Excellent parts availability
- Assured high performance quality
- Manufactured to OE standards.



# MORE POWER FOR THE TOUGHEST JOBS

Whether it's construction, road building, forestry, winter clearance or public maintenance: this tractor is highly versatile. For each and every application there are numerous options that you can adapt to meet your individual requirements. They make light work of energy-sapping PTO applications with a soil stabiliser at crawling speed or quick transport trips with a fully laden dump trailer. With e23 or AutoPowr transmission, you can work flexibly and fuel efficiently.



## FRONT LOADERS FOR 7R SERIES TRACTORS

We have designed our H480 front loaders not only for a range of agricultural applications. Even the most challenging non-agricultural applications can be handled with this loader, supported by the most durable Category 2 implement carrier. All loader functions are controlled with the perfectly integrated electronic joystick on the CommandARM. This guarantees smooth operation and the highest possible level of operator comfort.

The H480 is the strongest and most robust loader in the industry and utilises mechanical self-levelling linkage to maximise lift capacity and maintain a level load as the loader is raised.





**A POWERFUL ALL-ROUNDER**

You will find 7R tractors hard at work in all kinds of non-ag applications. For example, the 7R's ability to shift massive payloads and its excellent PTO performance make it ideal in construction and road building projects or in use for snow removal.





## SPECIFICATION 7R SERIES TRACTORS

	7210R	7230R	7250R	7270R	7290R	7310R
<b>ENGINE PERFORMANCE</b>						
Rated Engine Power (97/68 EC), hp (kW)	210 (155)	230 (169)	250 (184)	270 (199)	290 (213)	310 (228)
Rated Engine Power with IPM (97/68 EC), hp (kW)	240 (177)	260 (191)	280 (206)	300 (221)	320 (235)	340 (250)
Max Engine Power at 1,900 rpm (97/68 EC), hp (kW)	231 (170)	253 (186)	275 (202)	297 (218)	319 (235)	341 (251)
Max Engine Power with IPM at 1,900 rpm (97/68 EC), hp (kW)	249 (183)	269 (198)	290 (213)	305 (224)	332 (244)	352 (259)
Rated Engine Power (ECE-R24), hp (kW)	202 (148)	221 (162)	240 (177)	259 (191)	278 (205)	298 (219)
Max Engine Power at 1,900 rpm (ECE-R24), hp (kW)	222 (163)	243 (179)	264 (194)	285 (210)	306 (225)	327 (241)
Max Engine Power with IPM at 1,900 rpm (ECE-R24), hp (kW)	239 (176)	259 (190)	279 (205)	293 (215)	318 (234)	338 (249)
Constant Power Range (rpm)	1,550-2,100	1,550-2,100	1,550-2,100	1,550-2,100	1,550-2,100	1,550 – 2,100
PTO Torque Rise, %	40	40	40	38	40	40
PTO Power Bulge, %	10	10	10	10	10	10
Engine Peak Torque @ 1,600 rpm (Nm)	983	1,077	1,171	1,245	1,358	1,452
Rated Speed, rpm	2,100					
Manufacturer	John Deere PowerTech PVS 6.8 L (B20 Diesel Compatible)	John Deere PowerTech PSS 6.8 L (B20 Diesel Compatible)			John Deere PowerTech PSS 9.0 L (B20 Diesel Compatible)	
Type	Diesel, in-line, 6-cylinder, wet-sleeve cylinder liners with 4 valves-in-head					
Aspiration	Single Turbocharger with variable geometry – air-to-air aftercooling and cooled exhaust gas recirculation	Dual Series Turbocharger with fixed geometry first stage & variable geometry second stage – air-to-air aftercooling and cooled exhaust gas recirculation				
Aftertreatment	Longlife & maintenance-free diesel particle filter (DPF), Diesel oxidation filter (DOC), Selective Catalytic Reduction (SCR) with DEF					
Engine Air Filter	Dual stage with engine cooling fan aspiration					
Cylinder / displacement, l	6 / 6.8				6 / 9.0	
Bore and stroke, mm	106 x 127				118.4 x 136	
Lubrication	Full-pressure, full-flow filtration with bypass					
Fuel Injection	Electronically controlled, high-pressure common rail with electric fuel transfer pump (self priming)					
Fuel filter System	Two Stage with water separator and service indicator light					
<b>TRANSMISSION OPTIONS</b>						
<b>e23 Transmission with Efficiency Manager</b>						
23 Forward- / 11 Reverse Gears, 40 km/h, left & right hand reverser	Standard – 40 km/h @ 1,560 rpm with 205 cm tyres			Standard – 40 km/h @ 1,600 rpm with 205 cm tyres, Option – 40 km/h @ 1,520 rpm with 215 cm tyres		
23 Forward / 11 Reverse Gears, 50 km/h, left & right hand reverser	Option – 50 km/h @ 1,860 rpm with 205 cm tyres			Option – 50 km/h @ 1,900 rpm with 205 cm tyres, Option – 50 km/h @ 1,800 rpm with 215 cm tyres		
<b>AutoPowr</b>						
Variable, 0.05 – 42 km/h, left & right hand reverser	Option – 40 km/h @ 1,330 rpm with 205 cm tyres			Option – 40 km/h @ 1,360 rpm with 205 cm tyres, Option – 40 km/h @ 1,290 rpm with 215 cm tyres		
Variable, 0.05 – 50 km/h, left & right hand reverser	Option – 50 km/h @ 1,660 rpm with 205 cm tyres			Option – 50 km/h @ 1,700 rpm with 205 cm tyres, Option – 50 km/h @ 1,620 rpm with 215 cm tyres		
<b>AXLES</b>						
<b>Rear Axles</b>						
110 x 2,550 mm (4.33 x 100.4 in.), variable range	Standard					
120 x 2,550 mm (4.72 x 100.4 in.), variable range	N / A			Option		
Flange Axle, 335 mm bolt circle	Option					
<b>Front Axles</b>						
1300 Series MFWD with Triple Link Suspension	Standard					
1300 Series MFWD with Triple Link Suspension and with Wet Disk Front Brakes	Option for 40 km/h, Mandatory for 50 km/h and/or 215 cm tyres					
Tread Range (depending on tyre sizes)	1,524 to 2,235 mm (60 to 88 inch)					

	7210R	7230R	7250R	7270R	7290R	7310R
<b>Differential Lock</b>						
Differential Lock – Rear Axle	Full-locking electro-hydraulic					
Differential Lock – Front Axle 1300 Series MFWD	Limited Slip					
Differential Lock – Front Axle 1300 Series MFWD with Wet Disk Front Brakes	Full-locking electro-hydraulic (actuated at same time as rear diff-lock)					
<b>ELECTRICAL SYSTEM</b>						
Alternator/Battery	Standard: 200 amps / 12 Volt Option: 240 amps / 12 Volt					
Total cold cranking amps	1,850 (2 batteries in parallel – 925 CCA, group 31 batteries)					
<b>STEERING</b>						
Type	Tilt-telescope with Memory					
Hydraulic power-steering with electric back-up pump	Standard – 406 mm Steering Wheel Diameter, Ratios / Turns Lock to Lock – 1300 MFWD (14.2 : 1 / 3.4)					
Active Command Steering (ACS) with electric back-up pump	Optional – 345 mm Steering Wheel Diameter, Variable ratio depending on speed: 15:1-23:1; Turns Lock to Lock 3.1-5.0; with Dynamic Road Wheel Offset Control, full electronic steering control and passive tactile feedback					
<b>HYDRAULIC SYSTEM</b>						
Type	Closed-centre, pressure & flow compensated system (PFC) with load sensing					
Main pump, axial piston (displacement)	Standard: 63 cm <sup>3</sup> – Optional: 85 cm <sup>3</sup>					
Maximum pressure	204 bar					
Rear Selective control valves with 1/2 inch ISO couplers	4 / 5 / 6 – Premium couplers with high pressure relief levers					
SCV controls	Electro-hydraulic control via paddle pods or optional electronic joystick on the CommandARM					
Rated flow, 63 cm <sup>3</sup> pump, l/min	162					
Rated flow, 85 cm <sup>3</sup> pump, l/min	223					
Maximum flow at a single Rear SCV, l/min	132					
Front SCV's	1 SCV in base with Front Hitch, 2 SCV's optional with Front Hitch					
Available flow at Front SCV's, l/min	126					
Oil Take out capacity, l	Standard: 65 / optional with auxiliary tank: 85					
Power beyond couplers	Optional (1/2 inch or 3/4 inch couplers)					
Mid mount electro-hydraulic valve stack	Optional, with 3 independent functions for an integrated operation of mid-mounted implement or front loader					
<b>REAR HITCH</b>						
Type	Electro-hydraulic Lower Link Sensing; load & depth control, infinite mix, float					
Category and Coupler System	3/3N, Hook Style Ends					
Lift capacity through full lift range, with Hook Style Ends (610 mm behind the coupler, OECD)	6,900 kg					Standard – 6,900 kg Option – 7,850 kg
Maximum Lift Capacity, with Hook Style Ends	9,200 kg					Standard – 9,200 kg Option – 10,200 kg
Lower Link Stabilization	Sway Blocks or Deluxe Sway Stabilizers					
Centre Link	Option – Hydraulic Centre Link – Cat. 3 (90 mm)					
<b>DRAWBAR &amp; TRAILER HITCH</b>						
Swinging Drawbar	Cat. 3 with 38 mm pin / Cat. 3 with 38 mm pin with heavy duty support					
Maximum Vertical Load	1,837 – 2,766 kg with Cat. 3, 4,535 kg with Cat. 3 HD					
3-in-1-hitch, with Cat. 3 drawbar	Optional					
Wagon hitch, mechanical or automatic, for 3-in-1-hitch	Optional					
80 mm Ball Hitch, for 3-in-1-Hitch	Optional					
Piton Fix Hitch, for 3-in-1-Hitch	Optional					
Pick-up hitch, with hook and Cat. 3 drawbar	Optional					
<b>FRONT HITCH, OPTIONAL</b>						
Type	Standard or Premium Front Hitch (less / includes pushbar and ground engaging lift arms)					
Category	3N					
Lift capacity through full lift range, with Hook Style Ends (610 mm in front of the coupler, OECD), kg	3,150					
Maximum lift capacity, kg	5,200					



## SPECIFICATION 7R SERIES TRACTORS

	7210R	7230R	7250R	7270R	7290R	7310R
<b>REAR PTO</b>						
Type	Electro-hydraulic switched via oil-cooled multi-disc clutch					
PTO 1,000 rpm (Engine rpm @ rated PTO speed)	1,950					
PTO 540 / 1,000 rpm (Engine rpm @ rated PTO speed)	1,950 / 1,950					
PTO 540E / 1,000 / 1,000E rpm (Engine rpm @ rated PTO speeds)	1,750 / 1,950 / 1,750					
PTO 540 / 540E / 1,000 rpm (Engine rpm @ rated PTO speeds)	1,950 / 1,750 / 1,950					
Stub diameter 45 mm (1-3/4 in.), 20-spline, 1,000 rpm	Standard					
Stub diameter 45 mm (1-3/4 in.) 20-spline, 1,000 rpm or 35 mm (1-3/8 in.) 6-spline/ 21-spline, 540/1,000 rpm, shifting at the rear of the tractor	Optional					
Stub diameter 35 mm (1-3/8 in.) 6-spline 540E rpm / 21-spline 1,000/1,000E rpm, or 45 mm (1-3/4 in.) 20-spline 1,000 rpm, Electronically Shiftable in Cab	Optional					
Stub diameter 35 mm (1-3/8 in.) 6-spline 540/540E rpm / 21-spline 1,000 rpm, or 45 mm (1-3/4 in.) 20-spline 1,000 rpm, Electronically Shiftable in Cab	Optional					
<b>FRONT PTO, OPTIONAL</b>						
Type	Electro-hydraulic switched via oil-cooled multi-disc clutch					
PTO 1,000 rpm (Engine rpm @ rated PTO speed)	1,940					
Stub diameter 35 mm (1-3/8 in.), 6-spline, Type 1, 1,000 rpm, Counter-Clockwise Rotation	Optional*					
Stub diameter 35 mm (1-3/8 in.), 21-spline, Type 2, 1,000 rpm, Counter-Clockwise Rotation	Optional*					
Stub diameter 45 mm (1-3/4 in.), 20-spline, Type 3, 1,000 rpm, Counter-Clockwise Rotation	Optional*					
* Availability dependent upon destination						
<b>CAB</b>						
Specifications	CommandView III Cab, Laminated windscreen, Panorama Door, Automatic Heating/Ventilation/AirCondition <sup>1</sup> and Generation 4 CommandCenter Display					
Suspension	Optional – Hydraulic Cab Suspension Plus (HCS Plus) or ActiveSeat					
Noise level, dB(A)	68				72	
Cab glass area, m <sup>2</sup>	6.5					
Cab volume, m <sup>3</sup>	3.6					
Display	Generation 4 Command Center 4100 with 7 inch or 4600 with 10 inch Touchscreen Display					
<b>MISCELLANEOUS</b>						
AutoTrac Ready	Standard					
Modular Telematics Gateway (MTG)	Standard					
ISOBUS Implement Connection	Standard – AEF ISOBUS compliant					
JDLINK with Ethernet Harnesses for CommandCenter	Standard – JDLINK Access or JDLINK Connect					
ServiceADVISOR Remote (SAR) & Remote Display Access (RDA) with 5 year subscription	Available with JDLINK hardware and activations					

	7210R	7230R	7250R	7270R	7290R	7310R
MyJobConnect and MyJobConnect Premium	Available with Ultimate Connectivity Package					
Video input in CommandCenter for camera	1 Video input for 4100 Display, 4 Video inputs for 4600 Display, Using PAL or NTSC signal					
Immobiliser	Optional					
Hydraulic Trailer Brake System	Optional – Dual Line System					
Pneumatic Trailer Brake System	Optional – Dual Line System, incl. Air Dryer					
<b>CAPACITIES</b>						
Fuel tank, with e23 and 205 cm tyres, l	465					
Fuel tank, with AutoPowr and 205 cm tyres, l	520					
Fuel tank, with e23 and 215 cm tyres, l	N/A		490			
Fuel tank, with AutoPowr and 215 cm tyres, l	N/A		545			
DEF tank, l	23					
Cooling System, l	39.5			44.5		
Crankcase oil volume, l	26			23		
Transmission-Hydraulic system, l	160					
TLS Plus w/ Limited Slip, l	14.4					
TLS Plus w/ Diff. Lock, l	10.8					
Front PTO Oil, l	4.0					
Wheel Hub Without Brakes, l	3.8					
Wheel Hub With Brakes, l	3.9					
<b>DIMENSIONS AND WEIGHTS</b>						
Wheelbase MFWD / TLS, mm	2,925					
<b>Overall Length, mm</b>						
Incl. rear hitch and front weight support without / with suitcase weights	5,547 / 5,966					
Incl. rear hitch and front hitch in highest position	5,910					
<b>Overall Height – Distance from rear axle centre line to top of the cab, mm</b>						
with 205 cm tyre configuration	2,368					
with 215 cm tyre configuration	N / A		2,458			
<b>Overall Width, mm</b>						
Overall width <sup>2</sup> , in mm	2,550					
Flange to Flange width, in mm	1,892					
<b>Ground Clearance, mm</b>						
Front Axle Clearance <sup>3</sup> , in mm	495		668			
Drawbar clearance with 205 / 215 mm tyres, in mm	420 / N/A		420 / 463			
<b>Turning Radius</b>						
with 600/70R30 tyres @ 74.1" spacing, TLS, m	6.7					
with 620/75R30 tyres @ 82" spacing, TLS, m	N/A		8.7			
<b>Weights</b>						
Average Shipping Weight, kg <sup>4</sup>	10,675		10,980		11,120	
Average Payload Capacity, kg <sup>4</sup>	5,325		5,020		4,880	
Maximum Permissible Weight, kg	16,000					
<b>TYRE SIZES</b>						
Front axle max. tyre sizes, (diameter in cm)	600/70 R30 (160)		620/75 R30 (168)			
Rear axle max. tyre sizes, (diameter in cm)	800/70 R38 (205)		900/60 R42 (215)			

<sup>1</sup> CAUTION: The air-conditioning system contains fluorinated greenhouse gases (F-Gas). This is necessary for the air-conditioning system to function. Type of F-Gas: R-134a, F-Gas Mass: 2.27 kg, CO<sub>2</sub> Equivalent: 3.24 t, Global Warming Potential (GWP): 1430 (The greenhouse effect is 1430 times of the same amount of carbon dioxide in regards to a time frame of 100 years.)

<sup>2</sup> Overall width dependent on tyres, axle configuration and tread settings

<sup>3</sup> Equipped with 1300 TLS axle, with 160 cm tyres (600/70R30) for smaller models or with 168 cm tyres (620/75R30) for bigger models

<sup>4</sup> Equipped with TLS/AutoPowr/Flange axle/empty front weight support/hooks with sway blocks/3 in 1 hitch rails with wagon hitch/shipping fuel/rear tires 650/85R38 /front tires 540/65R34



# EDITIONS AND CONNECTIVITY PACKAGES FOR 7R SERIES TRACTORS



## EDITIONS FOR 7R SERIES TRACTORS

DESCRIPTION	PREMIUM	ULTIMATE
TLS+ front axle suspension, 40 degree swivel seat with CommandARM controls, iTEC headland management system, AutoTrac/ISOBUS ready, JDLink, Automatic Air Conditioner & Electrically adjustable right and left mirrors are in base		
<b>TRANSMISSION</b>		
e23 Transmission	●	●
AutoPowr Transmission	○	○
<b>CAB</b>		
Active seat	●	○
Cab suspension	-	●
4100 – 7" CommandCenter Display	●	-
4600 – 10" CommandCenter Display	○	●
Standard Light Package	●	-
Premium Light Package	○	●
Outside Mirrors – Power telescoping	-	●
Cooling compartment	○	●
Standard – radio	●	-
Premium – radio	○	●
Battery Disconnect Switch	●	●
<b>HYDRAULICS</b>		
Hydraulic pump 227 l/min	●	-
Hydraulic pump 321 l/min	○	●
4 electrical SCVs – Premium	●	-
5 electrical SCVs – Premium	○	●
6 electrical SCVs – Premium	-	-
Electrical joystick	○	●
Rear hitch with two sway blocks	●	-
Rear hitch with two deluxe stabilizers	○	●

Legend: ● base for package; ○ optional for package; - excluded for package



## CONNECTIVITY PACKAGES FOR 7R SERIES TRACTORS\*

DESCRIPTION	PREMIUM	ULTIMATE
AutoTrac Ready	Base	Base
Tractor Implement Automation	●	●
4600 – 10" CommandCenter Display	●	●
CommandCenter AutoTrac Activation	●	–
CommandCenter Premium Activation	–	●
JDLink Access	●	–
JDLink Connect	–	●
MyJobConnect / Premium	–	●/○
StarFire 6000 – SF1	○	○
StarFire 6000 – SF3	○	○

**Legend:** ● base for package; ○ optional for package; – excluded for package

*\* Elements of the Connectivity Packages are a limited promotional offer and include time based subscriptions. Be aware that some of the Connectivity Packages as well as elements could not be available in all regions. Please contact your local John Deere dealer for availability.*



# EFFICIENT. STRONG. RELIABLE.

7R SERIES









We have solutions to your challenges! John Deere is committed to keeping you up and running. That's why our products and technologies are quality-built, state-of-the-art and efficient. We've invested generously in building an effective dealer network so we can be like a good neighbour – there to help when you need us.

That's why all of our dealer employees are John Deere trained. They know every nut and bolt on your equipment and they're skilled at diagnosing any potential problems. Count on John Deere for all your tractor needs. With more than 175 years of experience in the farm equipment business, we can honestly say: Reliability is our Strength.

## NOTHING RUNS LIKE A DEERE



This literature has been compiled for worldwide circulation. While general information, pictures and descriptions are provided, some illustrations and text may include finance, credit, insurance, product options and accessories not available in all regions. Please contact your local dealer for details. John Deere reserves the right to change specification and design of products described in this literature without notice. The green and yellow colour scheme, the leaping deer logo and the JOHN DEERE word mark are trademarks of Deere & Company.