

Specifications

Model	GTH™-5021 R	
Measurements	Metric	Imperial
Lifting height maximum with outriggers	20.87 m	68 ft 5 in
Lifting height maximum without outriggers	20.65 m	67 ft 9 in
Lifting capacity maximum	5,000 kg	11,023 lbs
Lift capacity at maximum height	2,500 kg	5,511 lbs
Lift capacity at maximum reach	750 kg	1,653 lbs
Forward reach maximum	18.20 m	59 ft 8 in
Reach at maximum height	3.90 m	12 ft 9 in
A Height	2.99 m	9 ft 9 in
B Height at steering wheel	2.22 m	7 ft 3 in
C Width	2.42 m	7 ft 11 in
D Cab width	93 cm	3 ft
E Track	1.95 m	6 ft 4 in
F Wheelbase	3.00 m	9 ft 10 in
G Length at front wheels	4.81 m	15 ft 9 in
H Length at fork-holder plate	7.17 m	23 ft 6 in
I Ground clearance	30.6 cm	1 ft
L Overall width, outriggers extended	5.01 m	16 ft 5 in
M Side rear overhang	2.67 m	8 ft 9 in
N Side front overhang	4.40 m	14 ft 5 in
O Overall length	8.37 m	27 ft 5 in
MA Obstruction angle		21°
MB Departure angle		21°

Measurements

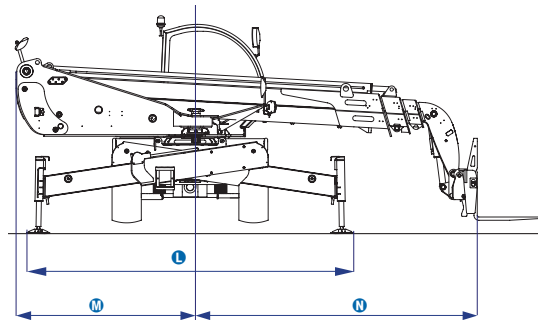
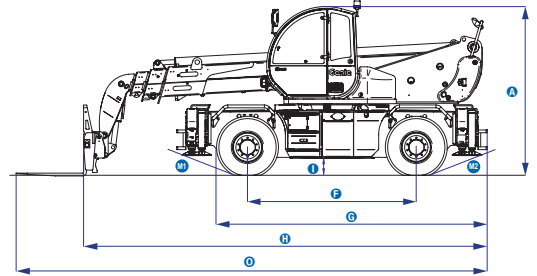

Productivity

Inside/outside turning radius	1.97 m/4.12 m	6 ft 6 in/13 ft 6 in
Break-out force (with 800 L shovel SAE J 732/80)	7,700 kg	16,975 lbs
Towing capacity at dynamometer*	7,880 kg	17,372 lbs
Drive speed max.	32 km/h	20 mph
Fork-holder plate rotation		138°
Tyres (DIN 70361)	18R19.5 TL XF 10 holes wheel disc	
Lifting/lowering speed*	21 sec./16 sec.	
Extension/retraction speed*	40 sec./20 sec.	

Power

Engine	Perkins 854E-E34TA turbo diesel 111 hp (83 kW), stage IIIB Perkins 1104D-E44T turbo diesel 100 hp (75 kW), stage IIIA	
Transmission	Hydrostatic variable displacement pump linked to variable displacement motor. Both piston type.	
Service pumps	Boom & Control system gear pump type: 280 Bar, 95L/min. Service Brake gear pump type: 180 Bar, 30 L/min.	
Petrol tank capacities	205 L	54 gal
Engine oil capacities	8 L	2.1 gal
Hydraulic oil tank capacities	220 L	58 gal

Weight**	17,180 kg	37,875 lbs
----------	-----------	------------

Standards Compliance

EU Machinery Directive 2006/42/EC
 Operating cab conforms to ISO3471 (ROPS) and ISO3449 (FOPS)
 Low emission engine conforms to EU Directive 97/68/EC Stage III and 2004/26/EC
 Noise emission conforms to EU Directive 2000/14/EC (LpA=83 dB, LwA=103dB)
 Vibration levels according to EN13059:2002 (hand-arm <2.5m/s², whole body 0.23m/s²)

* Without load

** Weight will vary depending on options and/or country standards

Load Charts

On wheels with forks

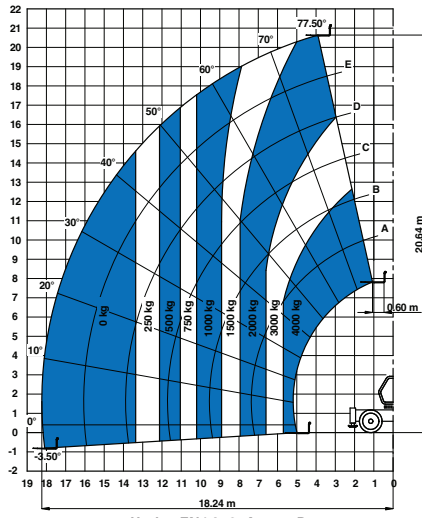

Under EN1459, Annex B

On outriggers with forks

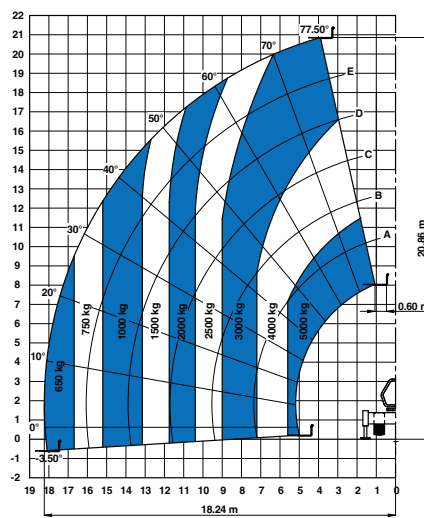

On wheels with 800 L shovel

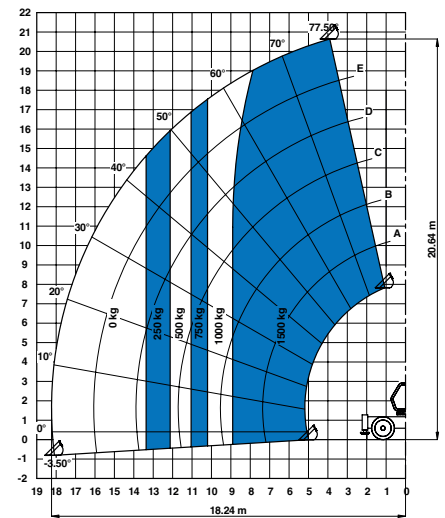

On outriggers with 5t fixed hook on plate

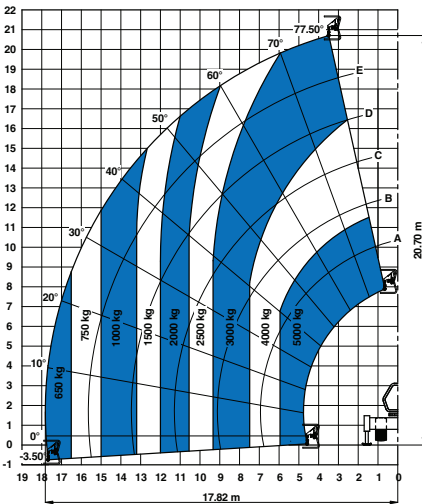

Under EN1459, Annex B

On outriggers with 2m jib (mechanical)

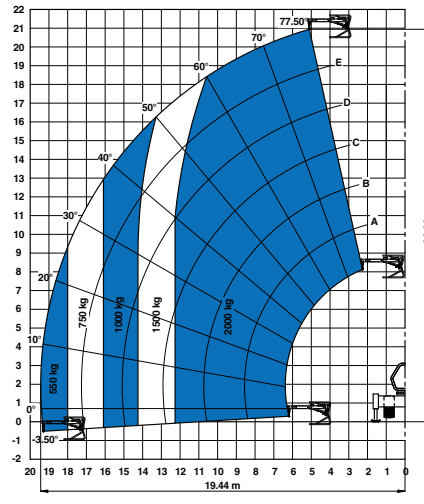

On outriggers with 4m jib (mechanical/hydraulic)

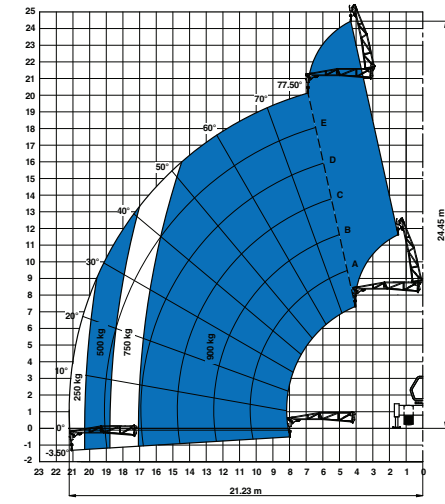

On outriggers with 4t hydraulic hoist

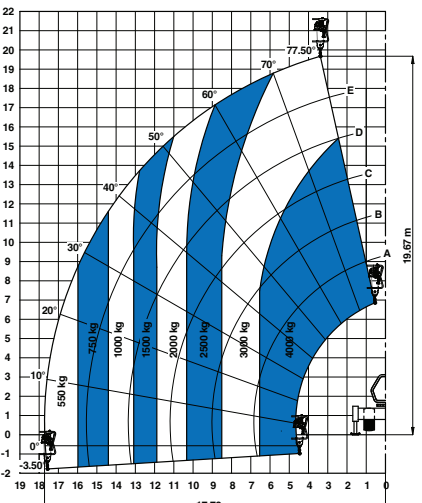

Under EN1459, Annex B

On outriggers with 2P-300F manplatform

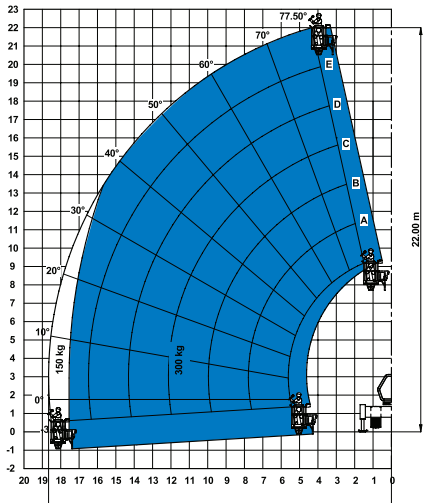

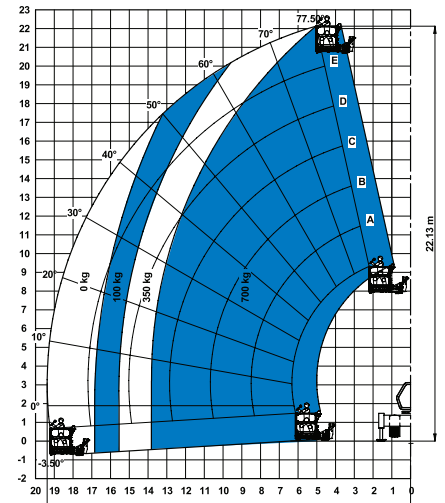

On outriggers with 3P-700REM 4400 manplatform



Attachment Options

Fork attachments

	Part Number	Description	Payload	Width	Length	Height	Weight
	55.0750.0033	Floating forks	4,000 kg	1375 mm	1625 mm	1125 mm	365 kg
	55.0750.0002	FEM 3 plate and forks kit	4,000 kg	1390 mm	1505 mm	1130 mm	380 kg
	59.0601.5003	Hydraulic FEM 3 forks side-shift +/- 100 mm	4,000 kg	1370 mm	1580 mm	1130 mm	520 kg

Dimension References

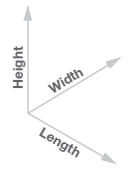



Bucket and shovel attachments

	Part Number	Description	Width	Length	Height	Weight	Hyd. flow max.
	59.0201.9004	800 L loading shovel	2435 mm	1070 mm	940 mm	450 kg	
	59.0400.0000	500 L concrete bucket manual discharge	1110 mm	1110 mm	1320 mm	230 kg	
	59.0401.2006	500 L concrete bucket hydraulic discharge	1110 mm	1110 mm	1320 mm	244 kg	60/220 L/min/bars
	59.0400.2000	800 L concrete bucket manual discharge	1110 mm	1110 mm	1520 mm	250 kg	
	59.0401.2007	800 L concrete bucket hydraulic discharge	1110 mm	1110 mm	1520 mm	264 kg	60/220 L/min/bars
	59.0401.2008	500 L concrete mixing bucket full hydraulic	1000 mm	1650 mm	900 mm	550/1850 kg	
	59.0400.7000	Brick holder basket	800 mm	1110 mm	1150 mm	120 kg	

Handling and lifting attachments

	Part Number	Description	Payload	Width	Length	Height*	Weight
	59.0700.9002	5T fixed hook on plate	4,000 kg	1335 mm	830 mm	1071/1115 mm	160 kg
	59.0802.3007	2m/2000 Kg mechanical jib	2,000 kg	1335 mm	2290 mm	800/1080 mm	255 kg
	59.0802.3008	4m/900 Kg mechanical jib	900 kg	1190 mm	4450 mm	980/1220 mm	270 kg
	59.0802.3012	4m/900 kg hydraulic jib	900 kg	1190 mm	4450 mm	1610/1220 mm	345 kg
	59.0901.9004	4T hydraulic hoist	4,000 kg	1335 mm	830 mm	1840/1260 mm	375 kg

Work platform attachments

	Part Number	Description	Payload	Width**	Length	Height	Weight
	59.1111.6012	Rotating and extendable +/-90° 3 persons max.	700 kg	2520 mm up to 4,610 mm	2110 mm	1850 mm	920 kg
	59.1111.6011	Fixed non extendable 2 persons max.	300 kg	2300 mm	1490 mm	1710 mm	400 kg

* Legs folded up/down
** Stowed/extended

Features

Standard Features

Measurements

- 5,000 kg (11,023 lb) maximum lift capacity
- 20.87 m (68 ft 5 in) maximum lift height
- 18.20 m (59 ft 8 in) maximum forward reach

Productivity

- 4 x 4
- 4 - wheel steer
- 3 steering modes:
 - front wheel steer
 - crab steer
 - coordinated steer
- Hydraulic line on boom
- Electrical line on boom
- Power assisted steering
- Front and rear outriggers
- 400 rotation (200 left, 200 right)
- Hydrostatic transmission with variable displacement pump and motor linked with a 2-speed mechanical gearbox
- Multifunction electro-proportional 5x1 joystick
- Limited slip differential on front axle
- Attachment holder plate - mechanical coupling
- Two-section door (glass upper/steel lower)
- Angle and length indicators on boom correspond to load charts
- Adjustable suspended seat with operator detection seat contact switch
- Battery disconnection switch
- Large diameter steering wheel

Standard Features

- Front & rear windscreen wipers
- Sunshield
- Roof protection grid
- Two side view mirrors & rear fish eye mirror
- Front & rear road lights
- Side mounted engine for easy access to components
- Oil immersed, multi-disc brakes on both axles
- Lockable fuel tank
- Lockable storage box
- Maintenance collar
- Rear wheel alignment system
- Road/jobsite switch
- Stability and load control system:
 - Load moment indicator with LEDs
 - Payload value numeric indicator
 - Audible alarm
 - Automatic lock-out of boom extension and lowering
 - Automatic lock-out of outriggers
 - Automatic lock-out of rear axle

Power

- Perkins turbo charged, air cooler diesel engine 111 hp (83 kW), stagellIB
- Perkins turbo charged diesel engine 100 hp (75kW), stagellIA

Tyres

- 18R19.5 TL XF 10 holes wheel disc

Options & Accessories

Productivity

- 360° Continuous rotation
- Chassis leveling
- Air conditioning
- Additional hydraulic line on boom
- Hydraulic quick coupling for attachments
- GM-1 Articulation for Manitou attachments
- Adjustable spotlight on boom
- Adjustable spotlight on cab
- Windshield protection grid
- Wiper on cab roof
- 6 t towing hook
- Outriggers extension plates
- Biodegradable hydraulic oil
- 10 t hydraulic jack + 24 mm box wrench
- External load moment visual indicator + buzzer
- Left-hand joystick
- Radio remote control
- Concrete mixing bucket pre-arrangement
- Work platform attachment pre-arrangement
- Comfortable seat
- Radio MP3
- Keypad unlocking device
- Track and trace
- 12 V charger

Tyres and Wheels

- Spare wheel 18R19.5 TL XF
- Foam filled tyre 18R19.5
- Foam filled spare wheel 18R19.5

Attachments

- Floating forks L 1200 mm, section 150x50 mm
- FEM 3 plate and forks kit
- FEM 3 forks with hydraulic side-shift (+/-100 mm)
- 800 L loading shovel
- 500/800 L concrete bucket (manual or hydraulic discharge)
- 500 L concrete mixing bucket (full hydraulic)
- Brick-holder basket
- Fixed hook on plate
- 2 m mechanical extension jib, 2,000 kg capacity
- 4 m mechanical or hydraulic extension jib, 900 kg capacity
- 4 t hydraulic hoist
- Fixed work platform
- Rotating and extendable work platform



United Kingdom

The Maltings, Wharf Road, Grantham NG31 6BH, T: +44 800 988 3739 (toll free), Fax +44 (0)1476 584334, Email AWP-InfoEurope@terex.com
Visit www.genielift.co.uk/locations to view our global locations list.

Worldwide Manufacturing And Distribution

Australia • Brazil • Caribbean • Central America • China • France • Germany • Italy • Japan • Korea • Mexico • Russia • Southeast Asia • Spain • Sweden • United Arab Emirates • United Kingdom • United States

Effective Date: February, 2014. Product specifications and prices are subject to change without notice or obligation. The photographs and/or drawings in this document are for illustrative purposes only. Refer to the appropriate Operator's Manual for instructions on the proper use of this equipment. Failure to follow the appropriate Operator's Manual when using our equipment or to otherwise act irresponsibly may result in serious injury or death. The only warranty applicable to our equipment is the standard written warranty applicable to the particular product and sale and we make no other warranty, express or implied. Products and services listed may be trademarks, service marks or trade names of Terex Corporation and/or their subsidiaries in the USA and many other countries. Genie is a registered trademark of Terex South Dakota, Inc. © 2014 Terex Corporation.

