

**Rotor Rakes**  
Single, Twin, Four



# Andex Rotary Rakes



*My way of Farming!*







# KEEP YOUR SYSTEM RUNNING

*My way of Farming!*



Working the land, running my farm and connecting with nature. Farming is my way of living, and despite being rough at times, I never grow weary of everyday tasks of attending to my land and livestock. I keep up with developments by staying loyal to personal philosophies and applying the appropriate strategy.

I shape and influence my own future by combining craftsmanship with modern technology, employing the very best machinery. I actively seek new opportunities, by being innovative in my way of working. I work hard to grow a good crop. I am passionate about my livestock, providing my animals with only the best. My farm and its returns, reflects who I am, because my heart and soul is put into the work I do.

Farming is about passion, about growing and developing, my crop, my farm, myself, my way.



# Durability *Exemplified*

Steplessly adjustable cam track for easy adaptation to different amounts and sorts of crop.

Injection moulded aluminium tine arm support housings provide strength and reduced weight.

Pinion gear with two bearings separate from the main driveline, keeping pinion and crown wheel securely in place.

All rotor star axes including housing can be removed individually by just removing 3 bolts.

Flat 400mm cast iron cam track with optimised shape, for smooth tine arm control and reduced running speed.

**“***Helping You*  
to Do More”

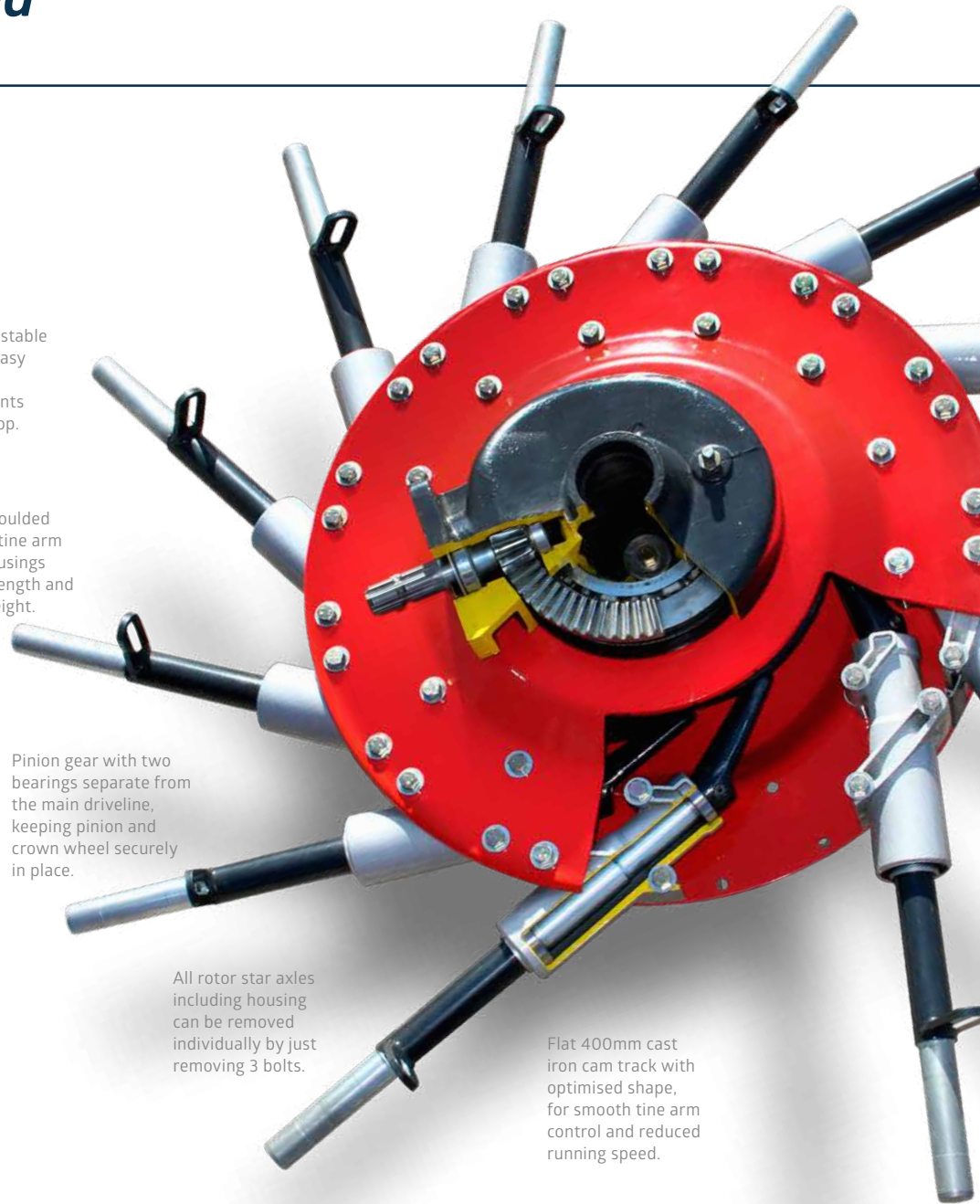





Oil-immersed crown wheel and pinion reduces wear to a minimum.

Heavy duty ball bearings with large distance for excellent support of tine arm shafts.

Guide rollers with hardened surface minimises wear on cam track and cam follower.

Unique 4-point ball bearing on crown wheel ensures efficient power transfer to the tine arms.

**ProLine**

The Andex ProLine rakes feature a unique drive system, which comprises oil-immersed pinion and crown wheels. The fully enclosed design ensures full and permanent lubrication, and makes the entire system absolutely maintenance-free.

Our extensive experience guarantees well-proven technology of the highest standard. The hardened cam track is adjustable and with an extremely large 400mm diameter, giving precise guidance to the tine arms and quiet machine running.

The optimised shape of the curve disc allows the tine arms to exit the crop faster, leaving a more uniform swath formation.

Aluminium bearing housings, with two integral ball bearings and wide support, provide solid and maintenance-free tine arm mounting. Additionally all tine arms including housing are removed by simply removing 3 bolts. Fast and easy!

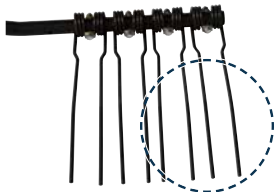

ProLine 10mm diameter tines.

Each tine arm can be dismantled and repaired individually.

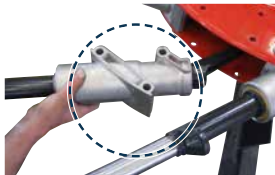



# Maintenance-Friendly *Solution*

Double bearings for crown wheel and pinion.

Maintenance-free cam track and tine arms, running in oil bath.

High tensile tine arm holders for strength and dependability.

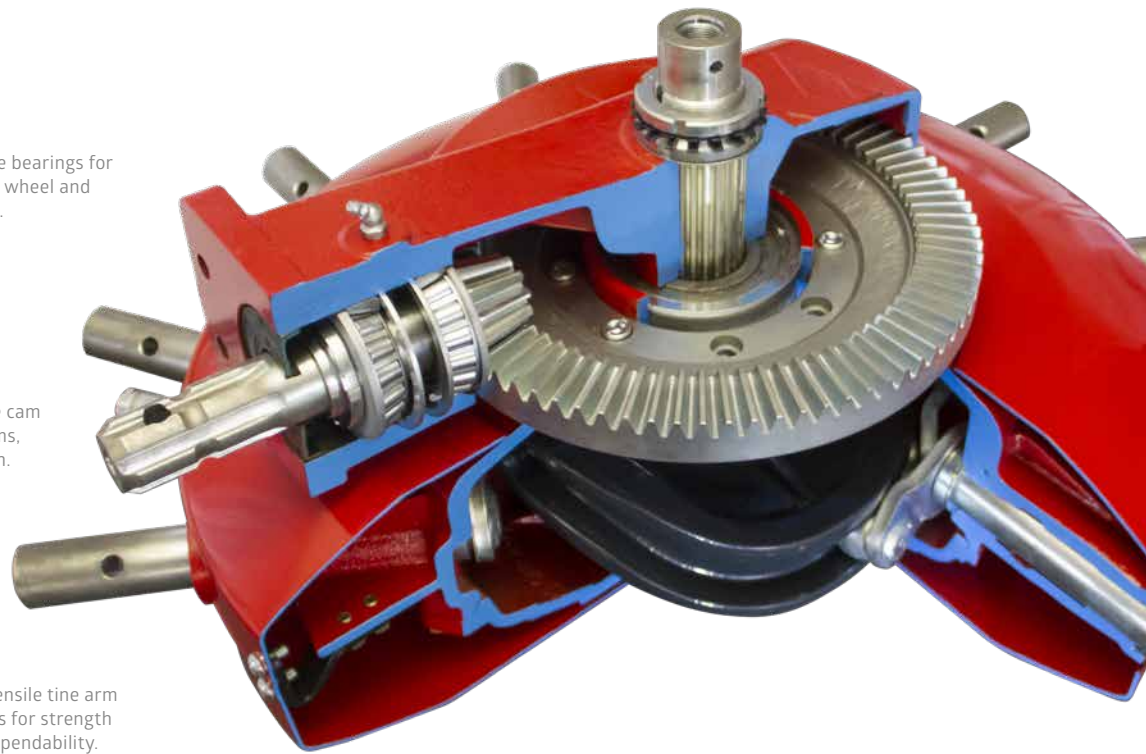

## **Curved Tine Arms**

Correctly adjusting and customizing the rake to the exact conditions facing you today is what adds the extra quality to your forage, ensuring that dirt stays out of the swath, yet leaving no crop behind. Setting the rotor height, adjusting the swath width and fine tuning the cam track (ProLine) is done easily and intuitively on all Andex rakes, taking the hassle out of the daily optimization.

The strong, yet flexible Vicon rake tines accurately move the crop into the swath, and with a wire diameter of up to 10mm they additionally provide the necessary capacity to move even large volumes of crop. The curved tine arms, a true Vicon hallmark, engineered to ensure that the tine arms will leave the swath at exactly the right time, promotes better and more accurate swath formation.

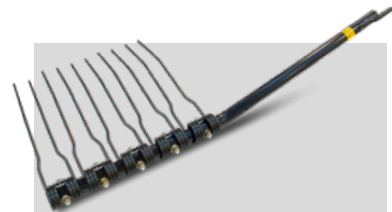

- Higher lifting out of the swath
- Increased capacity
- Faster drying rates due to better formed, more fluffy swaths
- Higher driving speed, as crop is pressed against the tines



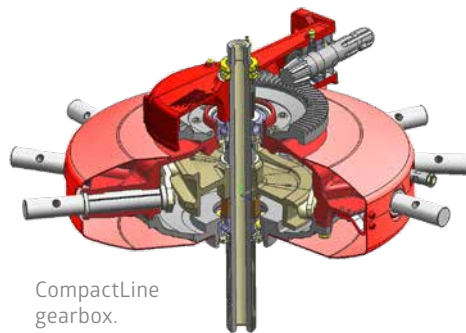

CompactLine gearbox.

**CompactLine**

The Andex CompactLine rakes features oil-immersed cam discs, guide rollers and tine bearings, alleviating maintenance on these components. Strong tine arms and bearings in an oilbath, ensure longevity and easy maintenance. The oil level of the gearbox is easily controlled from the outside.

High-tensile tine arm holders and two bearings on either side of the driveshaft, provide the compact unit with strength and dependability. Vicon-developed cam tracks are specifically manufactured for optimum raking at any working width and on any model.

“**Curved Tine Arms**  
for Perfect Swath Formation”

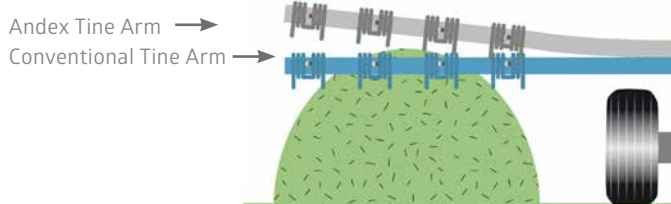

**Curved Tine Arms Supports Regular and Even Swaths**

All Andex rakes are fitted with curved tine arms, to ensure a regular and even swath formation. Additionally the curved shape prevents material from being pushed along the tine inside the rotor to increase capacity.

The specially angled tine arms ensure a higher lift out of the swath and leave the swath at just the exact right time in order to prepare regular and fluffy swaths.



# Stay on Track with TerraLink Quattro

*What really matters is the quality of the silage and hay, which you produce. Precision in every part of the raking process is paramount to ensure that none of the valuable material is left behind, while at the same time securing a clean and attractive crop without dirt.*

### Three-Dimensional Adaptation

The TerraLink Quattro system has become a true legend related to accurate ground following, vital to avoid dirt in the swath - especially in uneven field conditions.

It is a rather simple, yet unique system providing excellent 3-dimensional adaption to ground contours. And it is absolutely maintenance- and wear-free.

### The Strength is in the Arm

The openly constructed frame arm follows the principle of a torsion bar and absorbs vibrations away from the rotor and allows torsion flexibility, adding the extra tracking flexibility and stability of the rotor. Each rotor operates in 3 dimensions to accurately respond and adjust to uneven field conditions.

### High Stability

The trailed wheel axle configuration, where the weight is centered on the front boogie wheels, enhances quiet running and prevents lifting and tine bouncing. Each wheel is positioned as close as possible to the raking tines to ensure highest possible rotor stability, inviting for higher travel speed.

## How TerraLink Quattro Adapts in 3 Dimensions



The rotors are fully flexible in all directions, which means the tines have an exceptional ground following ability....

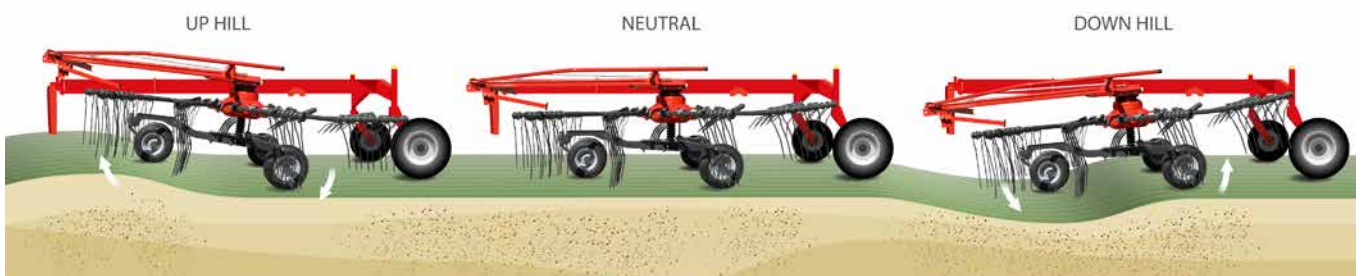

... ensuring a clean raking result without dirt in the crop.





## TerraLink Quattro for Accurate Tracking

Absolutely maintenance- and wear-free.

Unique combination of flexible frame arm and 3-dimensional rotor suspension.

The openly constructed frame arm absorbs vibrations away from the rotor and allows torsion flexibility.

The accurate tracking made possible by the TerraLink Quattro feature, ensures that a minimum of crop is lost during raking.

Rotor operates in 3 dimensions to accurately respond and adjust to uneven field conditions.



The trailed axle configuration enhances quiet running and prevents lifting and tine bouncing and invites for higher travel speed.

The boogie wheels are positioned as close as possible to the raking tines to ensure high rotor stability.

**“ Each rotor operates in 3 dimensions ”**

## The Real TerraLink Quattro Advantage

The TerraLink system consists of two parts. First the lifting arm and second the undercarrier. The arm is slotted on the downside. This, together with special steel quality, makes it possible for the frame to flex without breaking.





# ANDEX FOUR ROTOR RAKES

*My way of Farming!*





**ProLine**



**Andex 1505**  
Working Width: 9.8-15.0m

**CompactLine**



**Andex 1304 (PRO)**  
Working Width: 10.0-12.5m



**Andex 1254**  
Working Width: 10.0-12.5m





## The Only Real 15m *Working Width Machine*

### **15.00m Working Width**

The AnDEX 1505 is designed for high output and heavy use. Four rotors, maintenance-free ProLine gearbox, 15m working width and heavy duty mainframe design underline its' potential as a rake for the most demanding customer segment.

### **The Elbow Design Makes the Difference**

The special elbow design of the front rotor arms is a unique feature of the AnDEX 1505. Raking width can be matched to

differing crop characteristics, to obtain an evenly shaped and equally wide swath across the full width.

The design also allows quick working width adjustment. In case of contact with an obstacle, the overload protection on the outer arm ensures that it folds back at a certain pressure, securing the main frame structure from damages..

Also when raking along borders, the fast moving front arms can

be used to steer along fences etc. without slowing down. Specially while raking corners, it is possible to clean them in one go as the front rotor can be pushed inside the corner.

The biggest benefit with the system though, is that the next swath will still be straight, as the rotor towards the non-raked area stays in position.

When passing obstacles in the field, the front rotors can quickly be moved inwards, ensuring the swaths stays straight.





The unique elbow construction positions the front rotors close to the driver for excellent overview.

### Tackle the Terrain

The front rotors are fitted with hydraulic ground pressure control for constant adjustment of ground pressure. Regardless of chosen working width, ground pressure remains even, allowing the rotor to instantly react to uneven field conditions for accurate tracking. The advantages are obvious, as it leads to less damage and faster regrowth from the stubble and minimum dirt into the crop. Especially in wet conditions the low remaining weight on the rotor is a big advantage in order to get clean crop.



Each rotor can be independently and hydraulically set for height. As well a minimum height can be mechanically adjusted to secure a correct setting.



All 4 rotors can be lifted individually.

### A Superbly Manoeuvrable Unit

The 2-pt headstock allows a turning angle up to 80° and the optional unique steered wheel axles ensure these Vicon rakes have unequalled manoeuvrability. Despite a total length of 9.20m, even narrow gateways or approach lanes to fields are easily negotiated. For easy headland management it is possible to tailor the sequence of lifting and lowering the front and rear rotors, to optimize the time delay between front and rear rotors. Three different possibilities can be chosen. All 4 rotors can be lifted individually, allowing you to rake any size or shape of field in a professional and efficient way.

### Brakes and Tyres

The wide tires not only ensures gentle treatment of the ground, but also makes for excellent stability both in the field and on the road. Hydraulic or pneumatic brakes permit road speeds up to 40km/h.

All rotors are equipped with 3 twin wheels, 360° free turnable, for perfect guidance and no problem in narrow curves with destroyed grass fields.



High lift of rotors ensures generous clearance during headlands turns. Clearance height can be adjusted infinitely.





## Customize the Size *of Your Swath!*

**“Continuously  
Adjustable  
9.8-15.0m  
Working Width”**

### **Adjustable Working Width**

Raking width can be continuously varied on the move between 9.80m and 15.00m. Raking width can be matched to the density of crop to obtain an evenly shaped and equally wide swath over the full length.

Change of working width can be done in all situations, while driving, but as well while standing still with rotors on the ground. If the width needs to be adjusted shortly, the previously set working width can be recalled automatically.



The two outer rotors can be adjusted individually to match a working width between 9.8-15.0m.

**Everything Under Control with ISOBUS Technology**

The Andex 1505 is fully ISOBUS. This means that it will be plug and play with an ISOBUS compatible tractor without the need for a separate terminal.

The Andex 1505 is available with the IsoMatch Tellus or the IsoMatch Tellus GO control terminals. The IsoMatch Tellus GO is especially developed for controlling machines in a simple way. Just connect your machine, step into the tractor cab, switch on the power button and GO. The terminal brings the implement automatically into view. To maximise user comfort all buttons are positioned on right hand side of the terminal.



**Take Full Control**

The following functions can be operated with the terminals:

- Swath and working width.
- Programmable lifting height of rotors.
- Automatic selection of transport or working position by pressing an icon.
- Separate lifting of all four rotors.
- Setting of rotor height.
- Adjustment of working width, left and right hand side.
- Active and selectable hydraulic suspension on front rotors.
- Steering of transport axle.
- Headland management activation.
- Adjustment of delay time/meters or manual operation of headland management.
- Special customized user interface, developed with contractors, for very simple control of functions.
- Optional with joystick.

BreakBack system.



IsoMatch joystick.



The optional active wheel steering provides excellent manoeuvrability during narrow gateways and tight corners.



With its' clever folding mechanism the total height remains below 4.00m - despite a rotor diameter of 3.85m. And there is no need to remove tine arms for road transport.





## GEORAKE®

### *Simplify your Business*

*With the Vicon GEORAKE® solution, an accurate raking job, with well-shaped swaths, has never been easier. Once headland has been done, all you need to do is control the tractor. As GEORAKE® automatically lifts each rotor at just the right time, the stress factor of finishing swaths correctly, before turning on headlands, or in odd shaped plots is completely eliminated.*

#### **GEORAKE® is the Way to Precision**

To maximise output and quality of any raking job skill and precision is needed. Especially during headland operation. All rotors need to be lifted at just the right time, to rake up crop in the most efficient manner and prepare a perfectly formed swath for pick up.

This essential operation has now been fully automated, as each of the four rotors is individually controlled via section control, without any attention needed from the tractor driver.



**Discover this new Opportunities** with the Vicon GEORAKE® solution. An automatic lifting of each rotor at just the right time. Also available with the EXTRA 7100 as GEOMOW®.



As already raked areas are registered, each individual rotor will automatically lift for headland turns and in curvy areas.

#### **GEORAKE® Means Full Support to the Driver**

GEORAKE® registers already raked ground, so once a rotor enters into such an area, it will automatically lift. Each rotor operates individually and acts as one of four sections. When re-entering unraked area, the rotor will automatically lower at just the right time, to ensure complete raking.

“**Smart Raking Starts Here**”

When raking awkwardly shaped fields GEORAKE® avoids raking into already prepared swaths, automatically lifting the rotors involved, without any need for counter steering from the driver. Focus can be kept on driving and a perfect raking result.

No crop is left behind and no headland swaths are destroyed by interference from the rotors. Raking is done with high level of precision.

GEORAKE® is a license based application, and requires machine license and section control license for the Terminal. The Terminal license can as well be used for other operations like planters, spreaders and sprayers.



With GEORAKE® raking is done with high level of precision.

“**Improve Your Raking Performance**”





## Keep Things *Simple*

### **ProLine or CompactLine Specification**

The Andex 12.5m 4-rotor rake is offered with a choice of either ProLine or CompactLine gearbox. Both machines are similar in construction. They are built up on the same frame concept. The Andex 1254 CompactLine version is an easy-to-use machine with substantial working width for the professional segment, looking for a dependable machine to ensure stability in the complete harvesting process.

For heavy duty conditions, the Andex 1304 ProLine machine has been developed.

### **Boost Your Work Day**

Anderson 1254 and 1304 are targeted at making lighter work of tough and demanding operations. Being able to accurately feed the machine that follows and keep up efficiency of the complete harvesting system is an essential part of the raking job. With their impressive capacity of 12.50m working width, straightforward design and possibility to adjust both work and swath width from the cabin, these machines are designed to boost the complete process of collection and pick-up, altering to the changing crop intensity during the season.



**More Uptime with max 4m Transport Height**

No reason for wasting time, not even when moving between fields. Just raise the rotors and off you go, safely below 4.00m transport height – no need to leave the tractor for removing tines arms. Large transport wheels and hydraulic brakes are standard.

For storage all tines arms are detachable on Andex 1254 to allow a storage height as low as 3.40m. A strong and stable storage foot ensures fast and trouble-free coupling and uncoupling.

For Andex 1304 tine arms are generally fixed, but the top 4 are detachable, to reach same low storage height. A free run in the driveline secures that these arms will always be facing upwards.

“**Designed to Boost Capacity**”

Easy and intuitive control function, all handled from the tractor cab.



**Easy Handling – More Output**

Andex 1254 and 1304 are designed with uncomplicated work days in mind. Forget about sophisticated sensors and control functions, they are designed around the operator with simplicity in mind, focusing on the elements that adds real value. Take the control unit for instance.

It comes with a rather handy design including pre-selected functions for an array of easy operations. Only one double and one single acting spool valve are required to run Andex 1254 and 1304.



TerraLink Quattro is a unique combination of flexible frame arm and 3-dimensional rotor suspension.





## An Efficient *Farming System*



Working width can be set hydraulically between 10-12.5m. Swath width is also set hydraulically between 1.2 and 2.2m.

### **Excellent Swath Formation**

To prevent an uneven appearance of the swath and to keep capacity up, the rear rotors are smaller in diameter and turn faster. This secures the additional capacity needed on the rear rotors for the double volume, and as the speed is different it also prevents roping.

The maintenance-free TerraLink Quattro rotor suspension system, operating in 3 dimensions for excellent tracking, works in close combination with the 4 wheeled rotor to ensure high accuracy and stability on slopes. And it is absolutely maintenance- and wear-free.



**Hydraulic Adjustment of Working and Swath Width**

The hydraulic adjustment of working and swath width allows you to customize swath intensity and width to the capacity of the following machine. All conveniently handled and controlled from the tractor seat. Working width can be set between 10-12.50m and swath width can be adjusted between 1.20-2.20m, adding the necessary flexibility.

“**Compact**  
But Efficient”

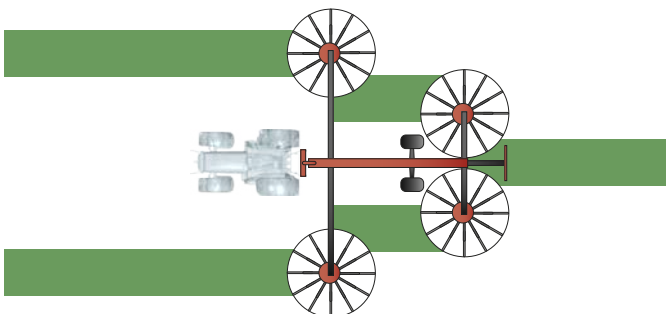

Compact but efficient machine - in combination with BX mower there is the possibility to collect up to 20m into one swath.



Optional tandem axle for additional stability specially on hillside.





## Professional Handling with Andex 1304 Pro – *Maximized Productivity*



### **Easy Headland Management**

These machines come with enhanced headland management. In addition to high ground clearance of rotors during headland turns, it is possible to tailor time delay between lifting/lowering the front and rear rotors to driving speed and field conditions. This is done mechanically in an easy and uncomplicated way.

Andex 1254 and 1304 will do sharp turns of up to 80°, both on headlands and during transport when passing narrow gate ways. The rotors can as a standard feature lift pairwise, convenient for raking crop away from fence lines or when raking low crop fields.

### Benefits of the 1304 PRO

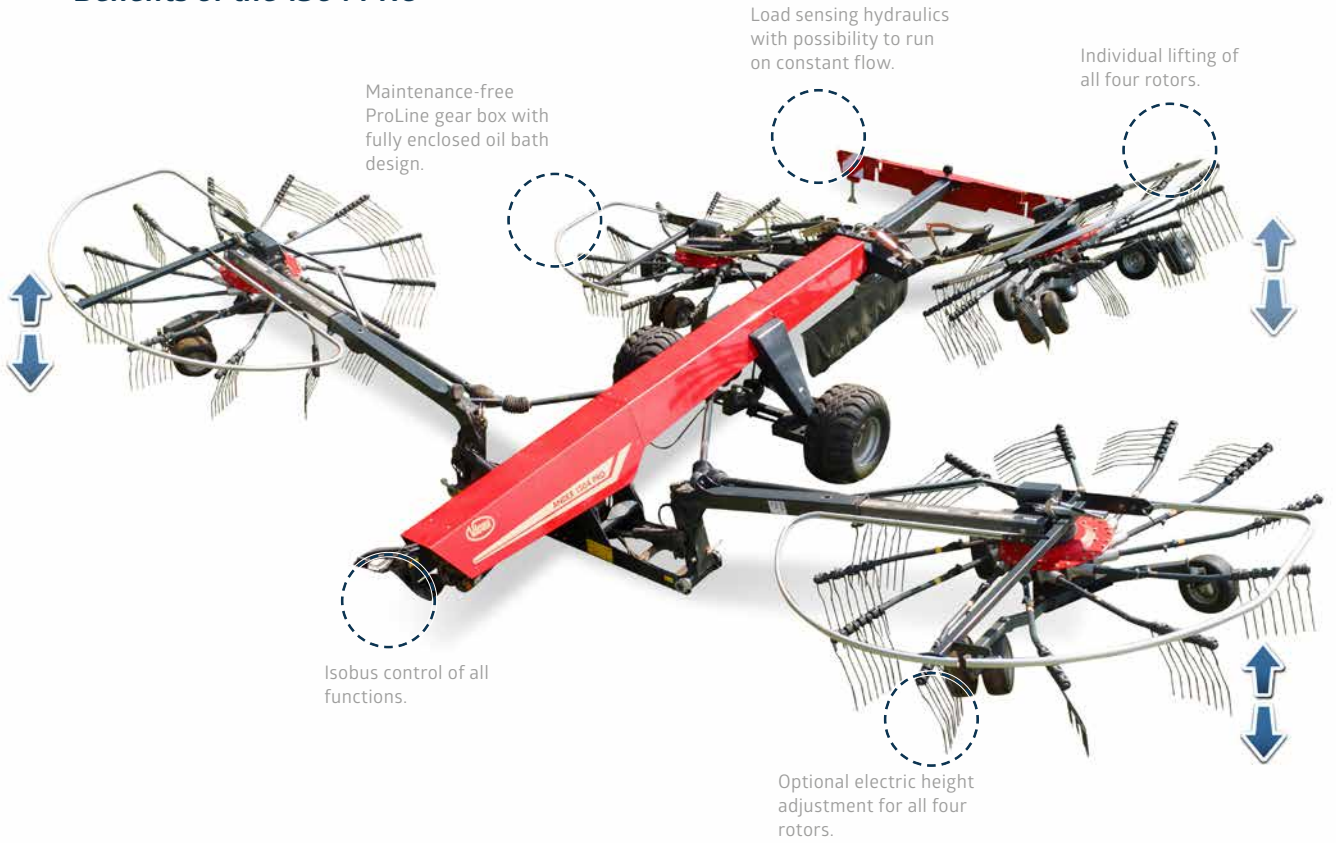

“**High Ground Clearance**  
during Headland Turns”



Andex 1254 and 1304 will do sharp turns up to 80°.



High lift of rotors ensures generous clearance during headland turns.



# ANDEX TWO ROTOR RAKES

*My way of Farming!*

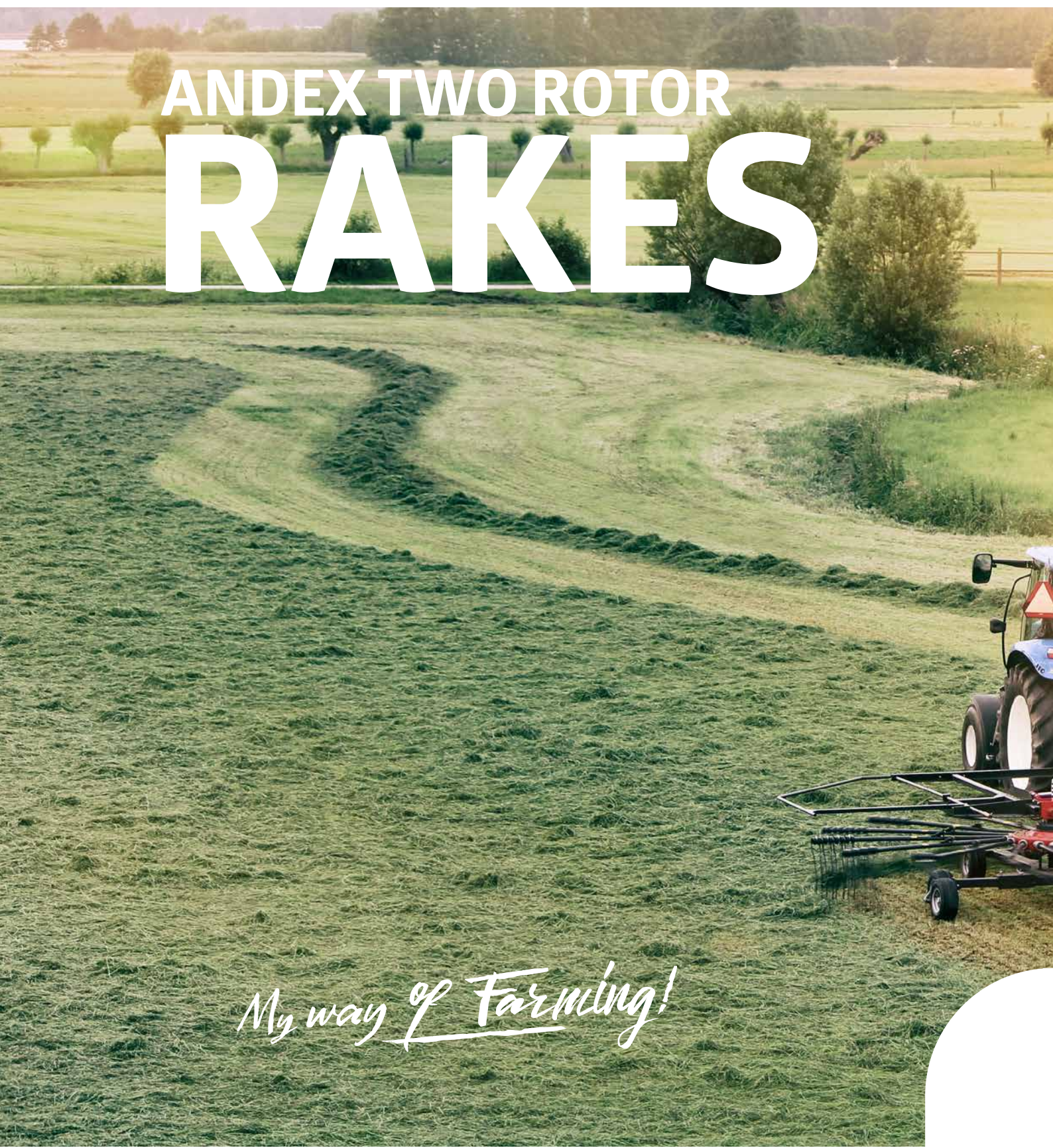





**ProLine**



**Andex 1104**  
Working Width: 9.3-10.6m  
**Andex 804-844-904 Hydro**  
Working Width: 7.0-9.0m



**Andex 774**  
Working Width: 7.7m

**CompactLine**



**Andex 644-644M-724 Hydro -764**  
Working Width: 6.4-7.8m



**Andex 694 Evo/Vario**  
Working Width: 6.9-7.9m  
**Andex 714T Evo/Vario**  
Working Width: 6.6-7.1m





## High *Performance*



Andex 1104 comes standard with tandemaxle and hydraulic height adjustment.

### **11m Working Power**

Andex 1104 - for the high performance segment, normally covered by more expensive 4-rotor rakes. Easy operation, excellent manoeuvrability and a heavy duty design characterize this machine. Despite a working width of 11.0m, the rake is very compact and manoeuvrable in the field. Standard on the machine, besides the height adjustment, is as well the individual lifting of the rotors and hydraulic height adjustment with the possibility of setting a mechanical minimum height.

### **TerraLink Quattro**

The Andex 1104 is fitted with the TerraLink Quattro system, offering perfect ground contour followings. A unique combination of an undercarriage with 6 wheels and a special designed rotor suspension, ensures a superb raking performance, even at high forward speed and with big rotor diameter.





**Easy Operation**

The AnDEX 1104 is designed for easy operation, with a number of features, making the working day as comfortable as possible.

**15 Tine Arms per Rotor**

With 15 double tangential tine arms and 4 double tines per arm, the AnDEX 1104 is well equipped for maximum raking performance. The high tine frequency ensures clean raking performance, even at reduced rpm and high forward speed.



**Adjustable Rotor Height**

Double acting hydraulic height adjustment of the rotors to suit the length of stubble or ground conditions, along with hydraulic suspension to reduce ground pressure.



**Adjustable Working Width**

Hydraulically adjustable working width to be set between 9.2 and 11.0m.



The AnDEX 1104 is equipped with an operator's box which includes all hydraulic functions of the machines. All functions can be pre-selected and then executed by operating the valve on the tractor. Even the transport lock is operated hydraulically.



Active wheel steering, allowing sharp turns on headlands and during transport.



To reach a transport height below 4.00m, the tine arms can be removed and placed safely on the carrier frame.





## The Heavy Duty *Centre Swath Rakes*



### **Durable Precision**

With adjustable working widths of 7.00m to 9.00m respectively these heavy duty specification rakes provide the swath formation capability to keep harvesting operations running at their optimum output. At the heart of all models is a heavy duty Pro-Line rotor head system. The machines are equipped with ground protecting 380/55-17 tires.

### **On-the-Go Rotor Height Adjustment**

A ComfortKit is optionally available for Andex 804 and standard on 904 Pro. This includes a hand-held joystick control that brings all control functions into one.

The height of each rotor is controlled electronically, and actual height of each rotor is shown on the screen of the control box. In this way fine tuning rotor height, improving your work result is easily done on the go.

A screen indicator shows the actual height in percent. It is as

well possible to set a personal zero point, to prevent too deep raking. On top the kit includes individual rotor lifting. It is possible to adjust the rotors together or individual in all positions.

### **Flexible Working Width**

Andex 804:  
7.00-8.00m working width.  
Andex 844:  
7.60-8.40m working width.  
Andex 904 Hydro:  
8.00-9.00m working width.  
Andex 904 Pro:  
8.00-9.00m working width.





### Excellent Manoeuvrability

The rear carrier frame with controlled steering facility gives this rake excellent track following characteristics, allowing tight turns on headlands and loss free swathing even in awkwardly shaped fields. Even if the rotors are lifted on a steep slope, the steering system reliably counteracts any deviation. During headland turns the rotors are lifted up to 45cm from the ground to prevent swath damage.

- Actively steered wheels for excellent tracking.
- Ability to make sharp turns up to 80°.
- High lift of minimum 45cm of rotors ensures generous clearance during headlands turns.
- Raking with only one rotor (standard on AnDEX 904 Hydro, optional on AnDEX 804 and 844).



AnDEX 844 with 8.40m working width, fully enclosed gearbox and hydraulic adjustable working width.

Hydraulic adjustment of working width.



Easy setting of correct raking height.



ComfortKit including electronic control of separate rotor height.





## More Uptime *with Clever Transport Solutions*

### **AnDEX 804 - Design Optimised for Transport**

The AnDEX 804 masters both extensive working width and compact transport measures. The new design of the wheel axles allows for the addition of generous 380/55 wheels as standard, whilst still offering a narrow outer track width, making it the perfect match for narrow roads and tight gateways.

Transport height is below 4.00m, even with all tine arms attached. No need to leave the tractor, just fold and go. Add in the 80° turning headstock and active wheel steering, and you have a highly manoeuvrable machine on road and in the field.



With 9.00m working width and transport height below 4.00m, even without detaching tine arms...



... the AnDEX 904 Hydro offers remarkable productivity with no downtime.

**AnDEX 904 Hydro - High Capacity in Field, Compact on the Road**

The AnDEX 904 Hydro will go as wide as 9.00m during work with its´ twin rotors, and offers the flexibility to adjust the working width between 8-9.00m. It will stay below 4.00m during transport, even with all tine arms fully mounted.

Thanks to the hydro axles, which are a unique Vicon feature, the complete rake can be lowered hydraulically for transport, ensuring that it will go

below 4.00m transport height. Another benefit is that the gravity point is moved towards the ground, and in combination with the wide track width and large 380/55-17 tyres it creates excellent weight distribution and stability during transport. AnDEX 904 Hydro comes as standard with a lift arm suspension and as well with single side lifting.

Standard running wheels of AnDEX 904 is extra wide 380/55 flotation tyres for excellent ground protection.



The AnDEX 804 includes a transport height below 4.00m without leaving the tractor cab and actively steered axles supporting tight turns on headlands and during transport.





## Cost-Effective ***Centre Swath Rakes***



*Vicon offers five cost-effective double rotor rakes with strong design. The rakes produce a nice even centre swath from raking widths of between 6.20m and 7.80m. They are mounted on a strong and stable frame to ensure long lifetime. Features such as actively steered wheels, the TerraLink Quattro system and hydraulically working width adjustment are standard - except for the low cost start up model Andex 644.*





**Find your Step from Single to Twin Rotor System**

When a single Rotor becomes too small and a two rotor rake is the obvious next size, then the AnDEX 644/644M is a fitting Entry Model to get more efficiency.

**Unique Manoeuvrability**

The rear carrier frame with controlled steering facility allows tight turns on headlands and loss free swathing even in awkwardly shaped fields. This gives ability to make sharp turns up to 80°.



Active wheel steering and sharp turns up to 80°.

**“Strong Frame  
Ensure Long  
Lifetime”**



Height of the carrier frame offers outstanding ground clearance on headlands.





## Compact Design – *High Performance*



The hydraulic adjustable rotors can be set between 7.00m...



...and 7.80m working width on An dex 764.

### **An dex 724 and 764**

Both An dex double rotor rakes offer hydraulically adjustable working width. This enables varying the swath width from 1.20-2.20m, ensuring a perfect match to the pick-up width of loader wagons, balers and foragers.



**Andex 724 Hydro - Resetting the Standard**

The Andex 724 Hydro is fitted with hydraulically operated axles on the mainframe, in order to lift and lower the machine during transport and operation. This feature significantly reduces transport height by 40cm, allowing a transport height as low as 3.45m.



Lifting the machine.



Lowering the machine.

Add in features such as adjustable working width of 6.2-7.2m, TerraLink Quattro ground contour following and heavy duty carrier frame design, and the result is low maintenance, higher productivity and maximum operation comfort.

As well the CompactLine gearbox, with all critical parts running in oil, helps to reduce maintenance time to a minimum.

All main functions, such as lifting and lowering of mainframe and rotors are operated from the tractor cab, using an electro hydraulic control terminal.

It is also possible to pre-select lift activation of the rotor units via the terminal. Such an integrated solution is offered only by Vicon.

**“Higher Productivity – Maximum Operator Comfort”**



Vicon centre swath rakes are converted hydraulically for transport from the tractor cab.



To limit transport height further the tine arms can be removed on the Andex 764. The swath board is folding up automatically.



The Andex multirotor rakes are fitted with TerraLink Quattro for excellent raking. Except for Andex 644.





## High Manoeuvrability *for Narrow Roads and Awkward Fields*



Compact transport position.

### **AnDEX 644M – Comfortable Dimensions**

The new compact AnDEX 644M shows with its compact mounted design in combination with the three point linkage high manoeuvrability for narrow roads and tight gateways. The mounting makes the AnDEX 644M then an ideal fit for mastering smaller and awkwardly shaped fields.

With its working width of 6.4m and 3.05m rotor diameter, it is suitable for raking 2x 3.2m mower swaths into one row.



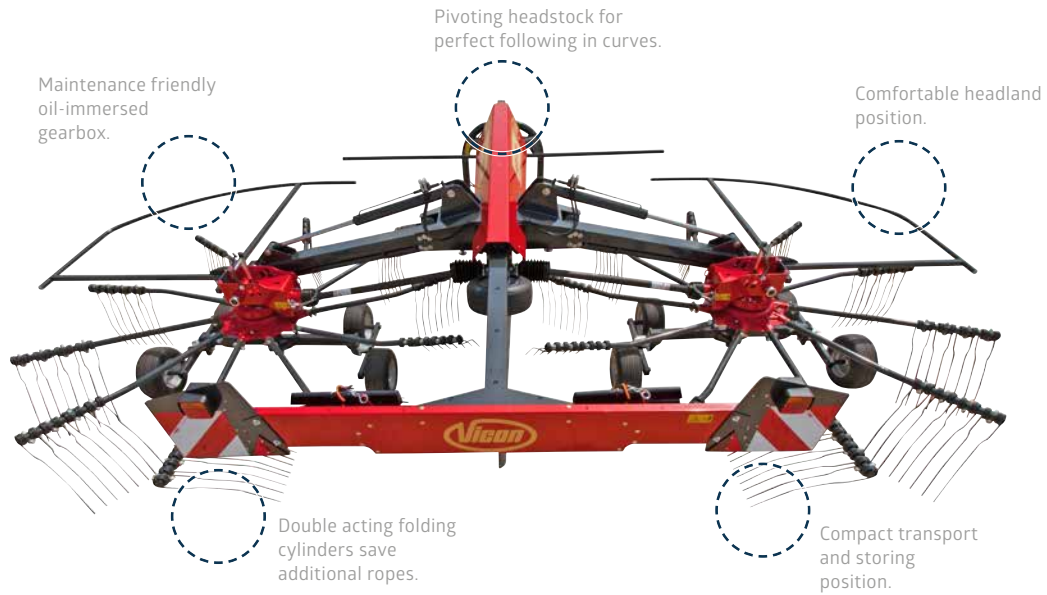

**The AnDEX 644M is set-up with simple technology:**

- No ropes for transport locks.
- Only two positions, folded or unfolded (double acting cylinders).
- No mistakes while operating.
- No need to operate with hydraulic valve during work.
- Easy headland lift with 3 point linkage.
- Outstanding clearance in headland position.
- Pivoting headstock to guide the machine freely along the field contour.
- Fixed wheels can be used.
- Together with stabilizers, a perfect performance also on hillside is guaranteed.
- Optional tandem wheels can even create a softer performing.



Tandem axle (optional).



Height adjustment.



Narrow and short transport position without leaving the cabin.



More flexibility by parking as no tine arms need to be detached.



Better ground adaptation compare to larger single rotor rakes.



High flexibility on the road, and in the field, as no carrier is disturbing.





Vicon AnDEX 694 EVO.

## Side Delivery Rakes – *Compact Effectiveness*



### The AnDEX 694 Side Delivery Rake

This compact and nimble rake features a sturdy frame and the well-proven TerraLink Quattro ground following system. In addition the Vario model offers the possibility of raking two separate swaths.



With a working width of 6.90m, the machine rakes up double swaths of up to 13.20m. There are 11 removable tine arms equipped with 4 tines on the front and 12 arms with 5 tines on the rear rotor in order to compensate for the higher load going through the second rotor and for a uniform swath

that is not wrapped together. A host of exciting details such as the well thought-out continuous driveline make AnDEX 694 a universal machine that suits a wide range of applications. Trailing boogie wheels made for tight cornering, without the risk of tilting the rotors. The two rotors provide generous overlapping and the cam tracks are matched to each other to transfer the material uniformly.

AnDEX 694 like all Vicon frame based rakes, features a headstock that turns through a 80° for superb manoeuvrability.





A hydraulic foldable swathboard is optionally available for AnDEX 774.



Active wheel steering for improved manoeuvrability in combination with large wheels for reduced compaction.



The side delivery concept allows you to collect crop from 15.00m into a single swath.



Vicon AnDEX 774.

### Double Up on Efficiency

The AnDEX 774 double rotor rake delivers a working width of 7.70m. The side delivery concept adds excellent flexibility in swath formation and allows you to collect crop from a working width of up to 15.00m into one swath. The high build mainframe concept offers excellent ground clearance in headland position. Actively steered wheels allow sharp turning, both on headlands and during transport.

AnDEX 774 is fitted with the renowned Vicon ProLine gearbox, with its' maintenance free oilbath solution. The shape of the Vicon hallmark, the massive 400mm curve disc, allows the tine arms to leave the crop faster, leaving a more uniform swath shape.

In addition the rotors have been upgraded to 12 tine arms on the front rotor, each with 4 tines, and 13 tine arms, each with 5 tines on the rear rotor. This ensures more accurate raking performance, without roping, and allowing higher forward speed.

Vicon side delivery rakes have steerable undercarriers on the front rotor to secure a smooth following in curves. As well a swath board on the first rotor stops the crop, so it can be picked up by the rear rotor (Option on AnDEX 694 Evo).

In addition AnDEX 774 is fitted with the Vicon TerraLink Quattro wheel system for superb ground contour followings. This system controls the rotor in 3 dimensions.

“**Accurate Raking Performance**”





## The Flexible Raking *Solution*



### **Flexible Raking**

The AnDEX 714T Vario and 714T Evo are designed for maximum flexibility for raking in different conditions. The twin rotors, working independently from each other, makes it possible to collect either one large swath or two smaller swaths.

Alternatively the rakes can place two large swaths into one, allowing a total of up to 12.50m crop to be gathered into one.

### **Vicon SideShift**

The Vario version also offers the patented SideShift system as an option, which comprises electro-hydraulic control of all functions. SideShift offers the possibility to side shift both rotors - both front and the rear - from the tractor cab. With this patented system, raking along field boundaries or around trees is no problem - as the tractor can run at a safe distance from the obstacles. It is also possible to drive with the tractor on already raked ground.





“**Electro-Hydraulic Control of All Functions**”



The 714T Vario with 7.10m working width and unique SideShift device.



SideShift to the right - conveniently passing trees.



SideShift to the left - raking without driving on unraked crop.

**Easy Conversion from Working to Transport Configuration**

There is no need to remove tine arms: moving the AnDEX 714T Vario and 714T Evo to transport position only requires a simple operation on the control unit. The swath deflector is lifted hydraulically and transport width for AnDEX 714T Vario and 714T Evo is only 3.00m (to reach 2.45m, the tine arms can be removed).



With 50cm lifting height, swaths can be driven over with no problem at all. Rotors are lifted using only a single acting valve.

The machine comes as Evo standard with tandem axle in the front. As Vario the machine is equipped as well with a land wheel standard (option for EVO) Optional the machine can be equipped with up to 13 wheels with tandem axle on the rear rotor and two sets of inner tandem axles on the front of the undercarrier

11 arms in the front and 12 arms in the rear secure a even swath and good crop flow, and prevents roping.



Both rakes are capable of placing small neat swaths for hay crops.



AnDEX 714T Evo/Vario in transport.



# ANDEX SINGLE ROTOR RAKES

*My way of Farming!*







**ProLine**



**Andex 424-464**  
Working Width: 4.2-4.6m

**CompactLine**



**Andex 323-353-394-434**  
Working Width: 3.2-4.3m



**Andex 424T-474T**  
Working Width: 4.2-4.7m





## Built-In *Reliability*



Tine arms can be easily removed.

### **High Performance**

Vicon's ProLine single rotor rakes offer a gearbox design with excellent working result. Features such as oscillation dampers, tandem axles and HydroLift height adjustment are standard hallmarks of the single rotor rakes.

### **HydroLift Concept**

A unique Vicon feature of the AnDEX 424 and 464 is the standard HydroLift concept. It is a hydraulic height adjustment system that allows the driver to quickly adjust working height to different ground conditions from the tractor cab as well including the possibility to mechanically set a minimum height.





For transport or storage, the rotor guard frames are folded up close to the mainframe, locking automatically into position. An assister spring linked to the swath board reduces the effort required.

**ProLine Gearbox**

The Andex single rotor rakes are based on the ProLine gearbox technology. These machines offer working widths of 4.20m and 4.60m respectively and are fitted with the renowned Vicon ProLine gearbox, with its' maintenance-free oilbath solution.

The shape of the Vicon hallmark, the massive 400mm curve disc, has been improved to allow the tine arms to leave the crop faster, leaving a more uniform swath shape.

Both rakes are standard fitted with both 4 wheel tandem axles and oscillation dampers, offering excellent ground contour following, minimizing the amount of dirt collected in the swath.



Oscillation dampers ensure excellent running characteristics.



As an option these rakes can be supplied with a third wheel, to ensure even better flotation.



Infinitely variable cam track adjustment allows fine tuning, to obtain optimum raking and swath formation according to crop conditions.

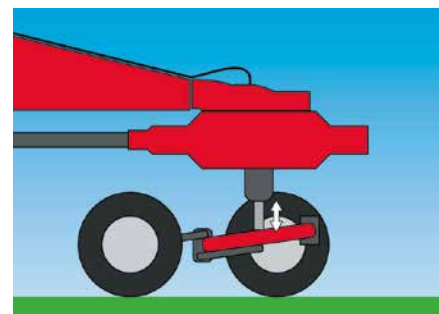

HydroLift height adjustment also offers the possibility to set a minimum height.





## Compact Design – *Low Maintenance*

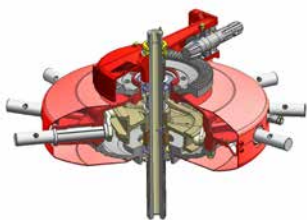

Compact design for easy maintenance.

### **The Compact Range**

For smaller raking operations, Vicon offers several models designed for use on lower horsepower tractors, whilst delivering similar raking performance compared to its' higher specification machines. With the pivoting three point linkage machines and also a trailed versions, there is a model to suit any need, from lowland farmers, to the users working on steep hillsides.

### **Index 'Compact' Rotor Head**

The rotor head is grease lubricated. Within a fully enclosed housing, the maintenance-free cam track and cam followers are running permanently lubricated in an oilbath. The rotor shaft and pinion shaft are all mounted on two bearings for maximum strength and long service life.





The AnDEX 394 with 3.90m working width for fast and effective raking action. Also perfect for turning straw swaths.

**Curved Tine Arms**

All AnDEX CompactLine rakes feature cranked tine arms for significantly cleaner raking performance and optimised swath formation. This design ensures that the row of tines on each tine bar has a more effective approach angle to the oncoming crop, and also gives a cleaner lift out of the tine from the formed swath.

As an option these rakes can be supplied with a third wheel, to ensure even better flotation.



The AnDEX 353 with 3.50m working width offers high performance with a simple, but reliable system.



All rakes can be set for reduced transport and storage width by removing the tine arms and placing them on the carrier frame.



A pivoting 3-pt headstock ensures perfect ground following performance, and perfect tracking when cornering. Oscillation dampers are optionally available.



AnDEX 474T – 4.70m working width and a weight of only 665kg.



With a linkage mounted drawbar, the AnDEX 474T can be easily operated by low horse power tractors.



The machine can conveniently be raised up to a height of 50cm from the tractor driver's seat.



# Combine Craftsmanship & Modern Technology *With our IsoMatch Precision Farming Offering*

*We believe in the freedom to choose your own approach. Precision farming is a way of life. Grow your crops, farm and self, your way.*

*Our precision farming offering consists of innovative and custom made equipment, designed to fit your personal vision and beliefs with respect to the heritage of your profession. Smart equipment accustomed to your way of farming. Now you can carry out the work in a smarter, more efficient and easier way to get the optimum out of your machines and crops, as well as saving time and money in fertiliser, chemicals and seeds.*



**NEW**

### Be innovative, Be a PRO

With its advanced hardware and software features, the IsoMatch Tellus PRO 12-inch terminal provides you with the optimal experience for an all-in-one control system inside the tractor cab including automatic steering. It is the centre for connecting all ISOBUS machines, and a platform for running precision farming applications and Farm Management Systems. It offers everything you need to get the best out of your machines and crop, as well as cost savings in fertiliser, chemicals and seeds by using automatic section control and variable rate control. With the unique dual screen functionality it gives you the opportunity to view and control two machines and/or processes simultaneously.

### A new level of comfort

As tractor steering with IsoMatch AutoDrive-E is handled automatically, you have the freedom to control and monitor your work in an easy way. While the work is more efficient and overlaps are avoided, you can completely focus on the result in the field. (Only in combination with IsoMatch Tellus PRO).

### New opportunities with farm management

IsoMatch FarmCentre is the first of a series of telematics solutions. This fleet management solution is applicable for all your ISOBUS machines in combination with an IsoMatch Tellus GO/PRO. Whether you wish to control your fleet, manage tasks remotely or analyse machine data, IsoMatch FarmCentre provides this in an efficient web application, linking implements, tractors, terminals and the cloud in one continuous flow of data and connectivity.

**NEW**

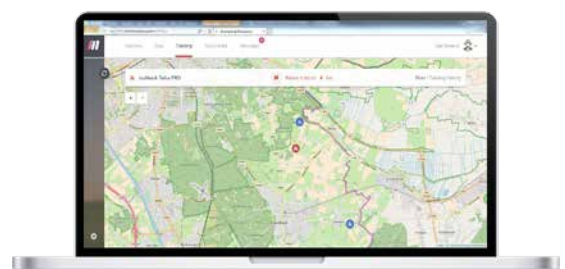



### Easy Machine Control

The IsoMatch Tellus GO is a 7-inch terminal, especially developed for controlling the machine in a simple way. You are in full control of the machine in exactly the way you want. Easily set up the machine with the soft keys via the 7-inch touch screen and for optimal control while driving simply use the hard keys and rotary switch. Controlling the implement has never been so easy.

### The right solution for perfect end results

The IsoMatch GEOCONTROL precision farming application includes Manual Guidance and Data Management free of charge. It is possible to expand this application with Section Control and/or Variable Rate Control.



“ **Discover New Opportunities**  
Choose Your Own Approach”

**NEW**



#### IsoMatch Grip

This ISOBUS auxiliary device is made for comfortable machine control and efficient farming. Its ergonomic shape and the complete freedom of assigning and controlling a total of 44 implement functions from one device are unique in the market today. From your fingertips you have endless possibilities to operate all machine functions as desired.

**NEW**



#### IsoMatch Global PRO

GPS antenna system with RTK precision (2-3 cm) for the highest accuracy possible. It brings you manual guidance, automatic section control, variable rate control and automatic steering in combination with IsoMatch GEOCONTROL.

#### IsoMatch (Multi)Eye

Connect up to 4 cameras to the IsoMatch Universal Terminals. It gives you full control and overview of the machine operation from every side you want.



#### IsoMatch InLine

Light bar for easy manual guidance. Mounted in the line of sight, you can easily see the distance from the A-B line and to which direction you should steer for the optimum position.





## Original Parts & Service

### ***It's What Makes Your Machine a Vicon***



***Original Vicon Parts are important pieces of your machine's DNA. Our parts are produced with the same strict specifications as the machine itself, and therefore guaranteed to work and fit as intended to keep you running at optimal pace.***

***We regard each sale of a Vicon machine as the start of a long term relationship. Our mission is to provide you with a safety net of parts and service to make sure your investment is running strong in the fields. Do not compromise the authenticity of your machine with cheap solutions, Original Vicon parts are the guaranteed solution for the optimal Vicon experience.***





### Your Parts Specialist

Your local Vicon dealer is always ready to assist you with parts and service. He is a loyal ally who knows every inch of your machine. Your dealer has all the parts you need, and will also have the facilities to service your machine.

“**Original Parts,  
the True DNA  
of Your Machine**”



### Always Available

Time is money, and we know the importance of receiving the right parts at the right time! Your Vicon dealer is supported by a massive distribution network to supply you with exactly what you need, when you need it.



### Easy Access To Information

Are you looking for a complete overview of parts for your machine? Maybe you are searching for more technical information? Our Online Search Database, *Quest*, provides all information available for your machine. Various documentation like Parts Manuals, Operation Manuals, Software updates and FAQ's, it is all there. *Quest* is available in several different languages and can be accessed wherever and whenever. All answers are easy to find – just a few clicks away!



# Facts

Model Index	Single Rotor Rakes								Double Rotor Rakes		
	323	353	394	424	424T	434	464	474T	644	644 M	694 Vario
<b>Dimensions &amp; Weights</b>											
Working width (m)	3.20	3.50	3.90	4.20	4.20	4.30	4.60	4.70	6.40	6.40	6.90/ 7.90
Working width (ft)	(10'6")	(11'6")	(12'10")	(13'9")	(13'9")	(14'1")	(15'1")	(15'5")	(20'10")	(20'10")	(22'8"/ 25'11")
Transport width (m)	1.60	1.75	1.75	1.75	2.00	2.10	2.15	2.40	2.80	2.85	2.85
Transport width (ft)	(5'3")	(5'8")	(5'8")	(5'8")	(6'6")	(6'9")	(7'1")	(7'9")	(9'2")	(9'3")	(9'3")
Transport length (m)	3.10	3.35	3.60	3.15	3.90	3.85	3.35	4.80	5.90	3.85	8.45
Transport length (ft)	(10'2")	(10'12")	(11'10")	(10'4")	(12'10")	(12'7")	(11')	(15'9")	(19'4")	(12'6")	(27'9")
Parking height (m)	1.60	1.70	1.85	2.60	2.30	2.00	2.75	2.65	3.85	3.81	3.45**/ 4.10
Parking height (ft)	(5'3")	(5'6")	(6'1")	(8'6")	(7'6")	(6'6")	(9'0")	(8'7")	(12'7")	(12'5")	(11'3"/ 13'5")
Weight (kg)	315	420	460	640	570	480	670	665	1510	1200	1930
Weight (lb)	(694)	(926)	(1014)	(1410)	(1256)	(1058)	(1477)	(1466)	(3329)	(2646)	(4255)
Swath width (m)	-	-	-	-	-	-	-	-	1.20	1.20	-
Swath width (ft)	-	-	-	-	-	-	-	-	(3'11")	(3'11")	-
Capacity theo. (ha/h)	3.5	3.9	4.3	4.6	4.6	4.7	5.1	5.2	6.9	6.9	7.6/8.7
<b>Hitching system</b>											
Pivoting 3-pt headstock (cat.)	1/2	1/2	1/2	2	-	1/2	2	-	-	-	-
Lower links (2-pt.)	-	-	-	-	-	-	-	-	●	●	●
Linkage drawbar	-	-	-	-	●	-	-	●	-	-	-
Gauge wheel 16°	0	0	0	0	0	0	0	0	-	-	-
<b>Rotors/Tine arms/Tines</b>											
Rotor diameter (m)	2.60	2.80	3.05	3.35	3.35	3.35	3.65	3.65	3.00	3.05	3.35
Rotor diameter (ft)	(8'6")	(9'2")	(10')	(11')	(11')	(11')	(12')	(12')	(9'9")	(10')	(11')
Swath delivery	left	left	left	left	left	left	left	left	centre	centre	left
Number of rotors	1	1	1	1	1	1	1	1	2	2	2
Number of arms per rotor	9	10	11	12	11	12	13	12	10	10	11/12
Number of double tines/ arm	3	4	4	4	4	4	4	4	4	4	4/5
Tine diameter (mm)	9	9	9	10	9	9	10	9	9	9	9
Adjustable cam track	-	-	-	●	-	-	●	-	-	-	-
Detachable tine arms/rotor	●	●	●	●	●	●	●	●	-	-	●
Height adjustment	rack trail	mech.	mech.	hydr.	mech.	mech.	hydr.	mech.	mech.	mech.	mech.
<b>Wheels and axles</b>											
Tyre (rotors)	15x 6.00-6	16x 6.50-6	16x 6.50-6	16x 6.50-6	18x 8.50-8	16x 6.50-6	16x 6.50-6	18x 8.50-8	16x 6.50-6	16x 6.50-6	16x 6.50-6
Fixed tandem axle	0	0	0	●	●	0	●	●	0	0	-
Pivoting tandem axle	-	-	-	0	-	-	0	-	-	-	-
Stand. tyres (carrying frame)	-	-	-	-	-	-	-	-	10.0/ 75-15.3	10.0/ 75-15.3	10.0/ 75-15.3
Opt. tyres (carrying frame)	-	-	-	-	-	-	-	-	-	-	-
<b>Optional Equipment</b>											
Lift arm susp./stabilisation	0	0	0	●	-	0	●	-	-	-	-
Locking catch for slopes	0	0	0	●	-	0	●	-	-	-	-
<b>Safety accessories</b>											
Warning panels	0	0	0	0	0	0	0	0	●	●	●
Road lights	0	0	0	0	0	0	0	0	●	●	●
● Standard	0 Optional	- Not available	* Double swath	** With detached tine arms	*** Hydraulically lowered main frame						

Information provided in this brochure is made for general information purposes only and for worldwide circulation. Inaccuracies, errors or omissions may occur and the information may thus not constitute basis for any legal claim against Kverneland Group. Availability of models, specifications and optional equipment may differ from country to country. Please consult your local dealer. Kverneland Group reserves the right at any time to make changes to the design or specifications shown or described, to add or remove features, without any notice or obligations.



Four Rotor Rakes														
694 Evo	714T Vario	714T Evo	724	724 Hydro	764	774	804	844	904 Hydro/Pro	1104	1254	1304	1304 Pro	1505
6.90 (22'8")	6.60/ 7.10* (21'8"/ 23.4")	6.60/ 7.10* (21'8"/ 23.4")	6.20/ 7.20 (20'4"/ 23'7")	6.20- 7.20 (20'4"/ 23'7")	7.00/ 7.80 (20'4"/ 25'7")	7.70 (25'3")	7.00- 8.00 (23'- 26'30")	7.60- 8.40 (24'11"- 27'7")	8.00- 9.00 (26'3"- 29'6")	9.20- 11.00 (30'2"- 36'1")	10.00- 12.50 (32'10"- 41')	10.00- 12.50 (32'10"- 41')	10.00- 12.50 (32'10"- 41')	9.80- 15.00 (32'2"- 49'3")
2.85 (9'3")	2.20**/ 3.00 (7'3***/ 9'10")	2.20**/ 3.00 (7'3*/ 9'10")	2.80 (9'2")	2.80 (9'2")	2.80 (9'2")	2.85 (9'3")	2.80 (9'2")	2.98 (9'8")	2.98 (9'8")	2.98 (9'8")	2.99 (9'8")	2.99 (9'8")	2.99 (9'8")	2.99 (9'8")
8.45 (27'9")	7.40**/ 8.20 (24'3***/ 26'11")	7.40**/ 8.20 (24'3***/ 26'11")	5.90 (19'4")	5.90 (19'4")	5.90 (19'4")	8.90 (29'2")	5.95 (19'52")	6.25 (20'6")	6.25 (20'6")	7.40 (23'3")	8.75 (28'8")	8.75 (28'8")	8.75 (28'8")	9.85 (32'4")
3.45**/ 4.10 (11'3"/ 13'5")	-	-	3.85 (12'7")	3.45***/ 3.95 (11'3"/ 13")	3.45**/ 4.10 (11'3"/ 13'5")	3.70**/ 4.10 (10'6"/ 12'10")	3.41/ 3.90 (11'2"/ 13'5")	3.45**/ 4.10 (11'3"/ 13'1")	3.50**/ 3.98 (11'6"/ 13'1")	3.45**/ 5.00 (11'3"/ 16'5")	3.45/ 3.99 (11'3"/ 13'1")	3.45/ 3.99 (11'3"/ 13'1")	3.45/ 3.99 (11'3"/ 13'1")	3.45**/ 4.00 (11'3"/ 13'1")
1740 (3836)	1400 (3086)	1350 (2976)	1640 (3615)	1680 (3704)	1640 (3615)	2160 (4762)	2065 (4553)	1950 (4300)	2350 (5181)	2865 (6316)	4300 (9480)	4700 (10362)	4700 (10362)	6000 (13228)
-	-	-	1.20- 2.20 (3'11"- 7'3")	1.20- 1.90 (3'11"- 6'3")	1.30- 1.90 (4'3"- 6'3")	-	1.20- 2.20 (3'11"- 7'3")	1.40- 2.10 (4'7"- 6'11")	1.40- 2.40 (4'7"- 7'10")	1.40- 2.70 (4'7"- 10'2")	1.20- 2.20 (3'11"- 7'3")	1.20- 2.20 (3'11"- 7'3")	1.20- 2.20 (3'11"- 7'3")	1.40- 2.50 (4'7"- 8'2")
7.6	7.3	7.3	7.5	7.5	8.4	8.5	8.8	9.2	9.9	12.0	13.8	13.8	13.8	16.5
-	-	-	-	-	-	-	-	-	-	-	-	-	-	-
●	-	-	●	●	●	●	●	●	●	●	●	●	●	●
-	●	●	-	-	-	-	-	-	-	-	-	-	-	-
-	●	0	-	-	-	-	-	-	-	-	-	-	-	-
3.35 (11') left	2.95 (9'6") left	2.95 (9'6") left	3.00 (9'10") centre	3.00 (9'10") centre	3.35 (11') centre	3.65 (11'12') left	3.35 (11') centre	3.65 (12') centre	3.85 (12'7") centre	4.55 (14'11") centre	3.05/ 3.35 (10'/11") centre	3.05/ 3.35 (10'/11") centre	3.05/ 3.35 (10'/11") centre	3.85 (12'7") centre
2 11/12	2 11/12	2 11/12	2 11	2 11	2 11	2 12/13	2 2x12	2 2x12	2 2x14	2 2x15	4 4x12	4 4x12	4 4x12	4 13/15
4/5	4	4	4	4	4	4/5	4	4	4	4	4	4	4	4/5
9	9	9	9	9	9	10	10	10	10	10	9	10	10	10
-	-	-	-	-	-	●	●	●	●	●	-	●	●	●
●	●	●	-	-	●	●	(4)	●	(4)	●	●	(4)	(4)	(4)
mech.	mech.	mech.	mech.	mech.	mech.	mech.	mech./ opt. hydr.	mech.	mech./ Pro - el.	hydr.	mech.	mech.	mech./ opt. hydr.	hydr.
16x 6.50-6	18.5x 8.50-6	18.5x 8.50-6	16x 6.50-6	16x 6.50-6	16x 6.50-6	16x 6.50-6	16x 6.50-6	16x 6.50-6	16x 6.50-6	16x 6.50-6	16x 6.50-6	16x 6.50-6	16x 6.50-6	16x 6.50-6
-	0	0	0	0	0	-	0	0	0	●	-	-	-	Terra
10.0/ 75-15.3	-	-	10.0/ 75-15.3	10.0/ 75-15.3	10.0/ 75-15.3	380/ 55-17	380/ 55-17	380/ 55-17	380/ 55-17	380/ 55-17	500/ 50-17	500/ 50-17	500/ 50-17	560/ 60-22.5
-	-	-	-	-	-	-	-	-	-	-	-	-	-	-
-	-	-	-	-	-	-	-	0	●	●	0	0	0	●
-	-	-	-	-	-	-	-	-	-	-	-	-	-	-
●	●	●	●	●	●	●	●	●	●	●	●	●	●	●
●	●	●	●	●	●	●	●	●	●	●	●	●	●	●

Safety devices may have been removed from the machines for illustration purposes only, in order to better present functions of the machines. To avoid risk of injury, safety devices must never be removed. If removal of safety devices is necessary, e.g. for maintenance purposes, please contact proper assistance or supervision of a technical assistant. ® = trade mark protection in the EU. © Kverneland Group Kerteminde AS











# Proud History of Ground Breaking Innovations

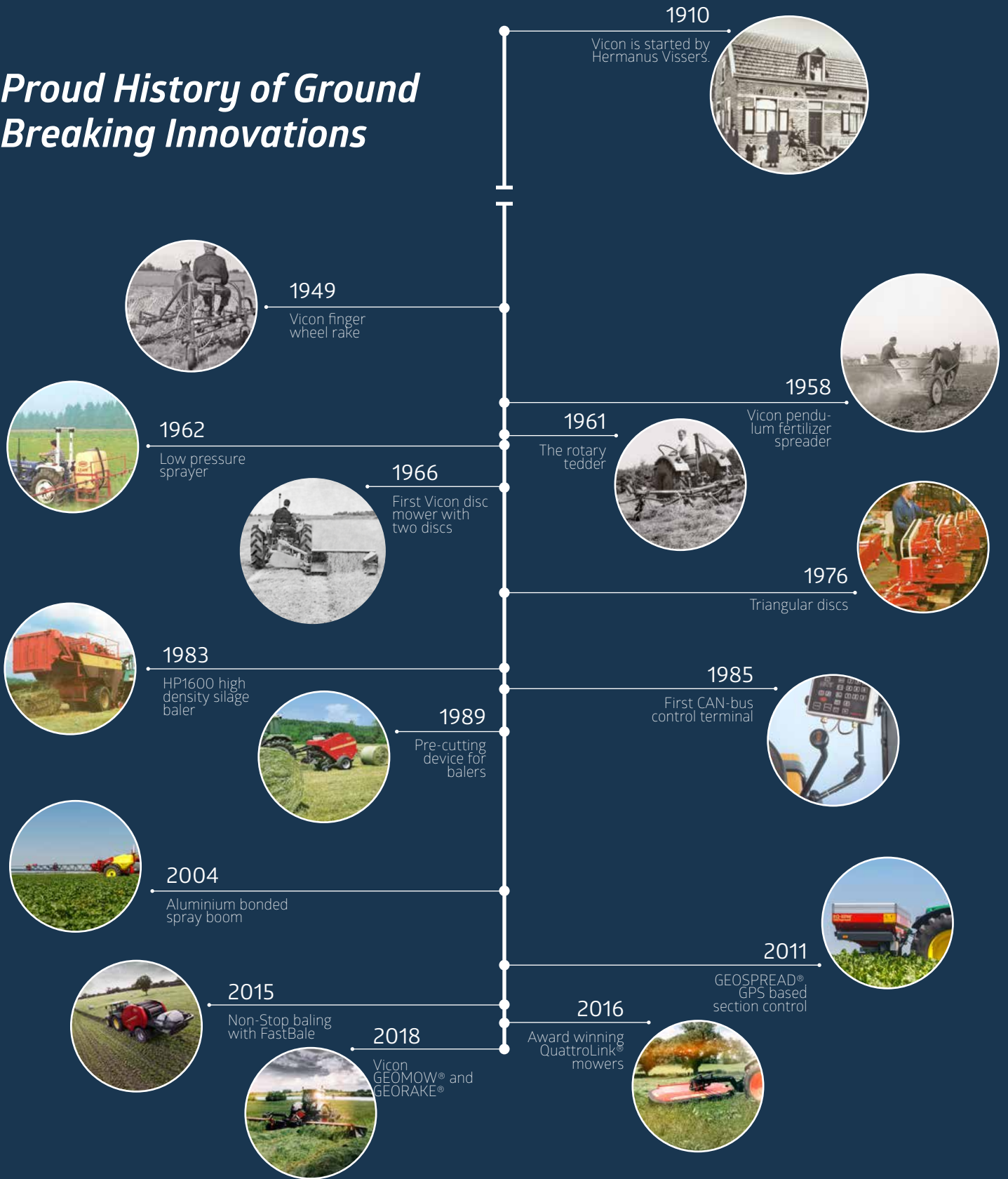

*My way of Farming!*



www.vicon.eu