



LGMG

MOBILE ELEVATING WORK PLATFORMS



LINGONG GROUP JINAN HEAVY MACHINERY CO., LTD.

Address: No. 2676, Kejia Road, Jinan, Shandong, China

Email: sales@lgmg.com.cn

Tel: +86-0531-67879283

LGMG Europe B.V.

Address: Laanweg 16 3208LC Spijkenisse Rotterdam, The Netherlands

LGMG North America, Inc.

Address: 1445 Sheffler Dr, Chambersburg, PA. 17201, USA

CONTENTS



P1-2

GROUP PROFILE

P11-20

ELECTRIC MOTOR DRIVE

- ✦ SS0407E SS0507E SS0607E
- ✦ SS0407ER SS0507ER SS0607ER **NEW PRODUCT**
- ✦ AS0607E AS0607WE AS0608E AS0808E
- ✦ AS0812E AS1012E AS1212E
- ✦ AS1413E **NEW PRODUCT**

P25-30

ROUGH TERRAIN SCISSOR LIFT

- ✦ SR1018E SR1218E **NEW PRODUCT**
- ✦ SR1018D SR1218D **NEW PRODUCT**
- ✦ SR1023D SR1323D SR1623D

P35-36

TELESCOPIC BOOM LIFT

- ✦ T20J T26J **COMING SOON**

P3-10

R&D, MANUFACTURING, GLOBAL SALES NETWORK

P21-24

HYDRAULIC MOTOR DRIVE

- ✦ AS0607 AS0607W AS0608 AS0808
- ✦ AS0812 AS1012 AS1212 AS1413

P31-34

ARTICULATING BOOM LIFT

- ✦ A14JE
- ✦ AR14J AR16J **COMING SOON**

P37-38

SERVICE & APPLICATIONS



GROUP PROFILE

Founded in 1972, Lingong Machinery Group is one of the key players in construction machinery, one of the top 100 enterprises in the machinery industry and one of the top four groups in the construction machinery industry in China.

The Group consists of three core companies, including: Shandong Lingong Construction Machinery Co., Ltd. (SDLG), Lingong Group Jinan Heavy Group's Co.,Ltd. (LGMG) and Lingong Special Machinery Co.,Ltd. The Group's business cover five sectors: construction machinery, mining machinery, MEWPs, special machinery and component manufacturing.

LGMG, located in Jinan, Shandong Province, China, is a privately-owned subsidiary of Lingong Machinery Group. Business segments include MEWPs, mining equipment. Today, LGMG has become an important player in the Chinese construction machinery industry. Holding a place as one of the top 100 global construction machinery manufacturers, the top 30 Chinese construction machinery manufacturers and the top 5 Chinese MEWPs manufacturers.

LGMG offers a wide range of electric and rough terrain scissor lifts, articulating and telescopic boom lifts.

In 2018, LGMG Europe was established in Rotterdam, the Netherlands to serve as a distribution and service hub for the EMEA market and in 2019, LGMG North America opened a headquarters in PA together with other three locations across the country in TN,HX,CA.

R&D TEAM

LGMG sees that R&D and innovation are key for sustainable growth, and has therefore established the Provincial Level Innovation, for new product development and component reliability tests. In addition, LGMG has collaborated with a top Chinese university to establish the LGMG Research institute, aiming to crack industry challenges and develop cutting edge technology, as well as have a profound effect on the cultivation on future talent for our industry.



GLOBAL SALES NETWORK

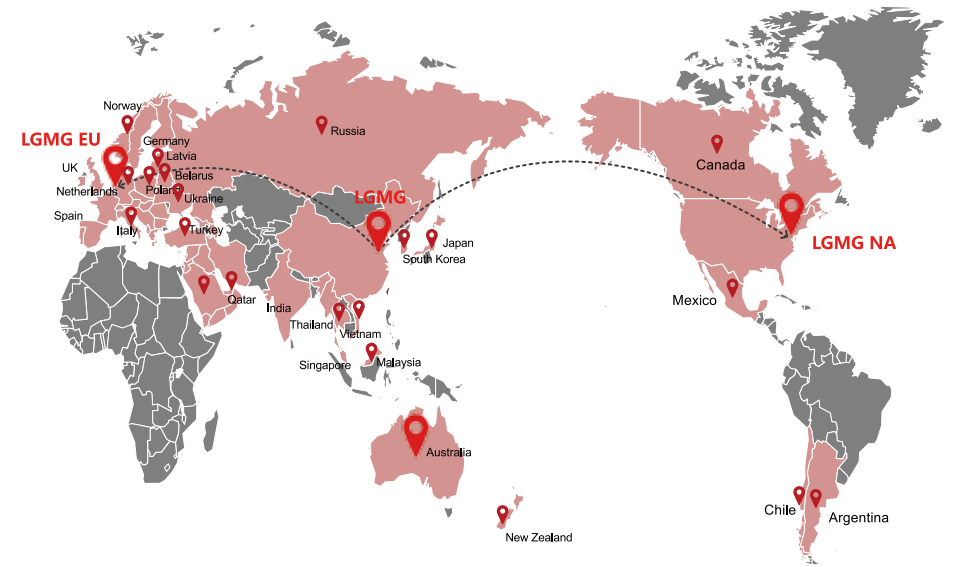

200+ PARTNERS

30+ COUNTRIES

- LOCAL TEAM SUPPORT**
- LOCAL MACHINE DELIVERY**
- LOCAL SPARE PARTS**
- LOCAL FAST AND HIGH QUALITY SERVICE**
- LOCAL TRAINING**



LGMG Europe.BV



LGMG North America, Inc

The establishment of LGMG European and North American companies has ensured quick and effective response times which fully meets our customers' requirements on machine inventory, parts and support with local professional teams. LGMG products have passed the major international standards such as CE, ANSI, Australia AS, CSA, KC, JIS, EAC. Products have been sold to over 200 partners in more than 30 countries around the world, including U.S., Canada, UK, Germany, the Netherlands, Italy, Spain, Korea and Japan.

1000 EMPLOYEES

4 PRODUCTION LINES

40 PRODUCT MODELS

(LPS 6 PRINCIPLES)

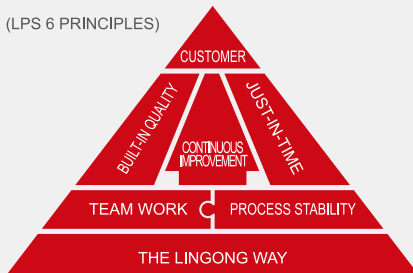

MANUFACTURING

LGMG's manufacturing base covers an area of 350,000 square meters, with an annual production capacity of 40,000 MEWP units. From parts welding and painting, to machine assembling and final product inspection, each procedure is strictly aligned with LGMG's Lean Production System (LPS 6 PRINCIPLES) to ensure the highest production efficiency and the best quality.



PRODUCT RANGE

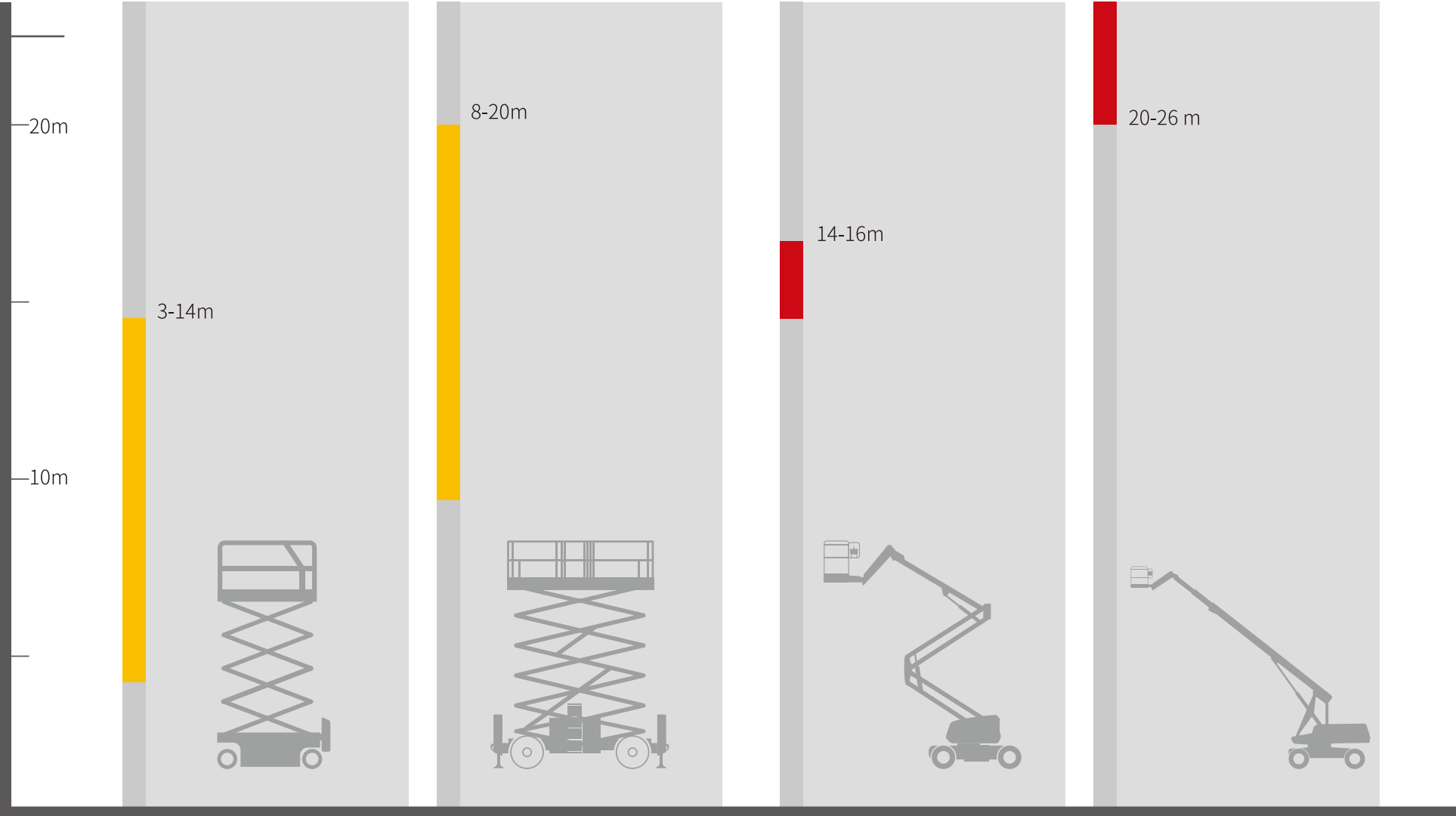

SELF-PROPELLED SCISSOR LIFT

PRODUCT CONFIGURATIONS

STANDARD FEATURES

- Proportional control
- Foldable guardrail
- Emergency stop device
- Manual brake release
- Emergency descent
- Swing-out component tray
- Pothole guard
- Self-lock entry gate
- Tilt alarm with lift cut-out
- Overload sensing system
- Descent alarm with flashing beacon
- Horn/hour meter
- All motions alarm
- Full-height drive
- Intelligent diagnostic system

OPTIONAL

- AC power to platform
- Maintenance-free battery
- Platform anti-collision device
- Air tube to platform
- Lithium battery
- GPS

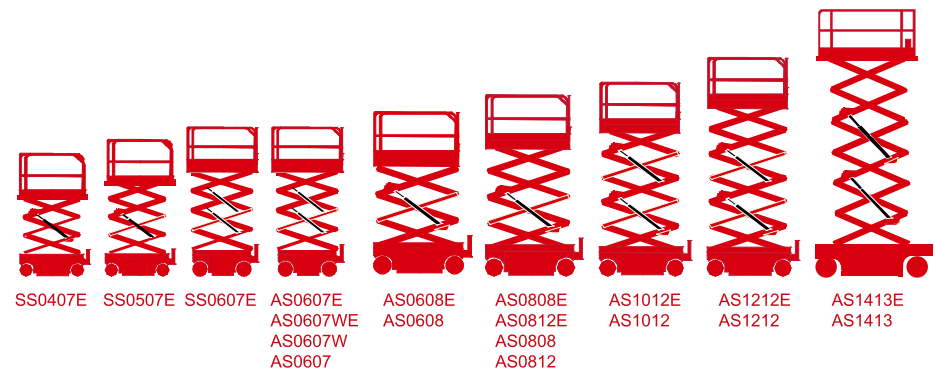
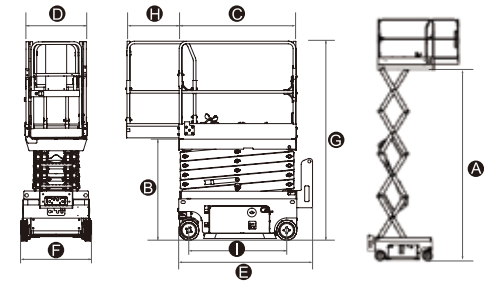

ELECTRIC MOTOR DRIVE SCISSOR LIFT

**SS0407E (SS1230E) / SS0507E (SS1432E)
SS0607E (SS1932E)**



HIGHLIGHTS

LGMG SS Series scissor lifts offer an ideal solution for the low-level access and tight restricted application job sites. Shorter overall machine length and lighter weight makes it suitable for most elevators.

- Battery powered, zero emission and quiet drive mean this machine is environmentally friendly.
- Efficient electric drive system provides longer-lasting performance and better gradeability.
- The zero turning radius and the light weight make this machine ideal for space restricted conditions, providing exceptional maneuverability.
- Exceptional waterproofed drive system design provides excellent performance in wet conditions.
- Commonality of control system with other electric scissor lifts.

SPECIFICATIONS

MODELS	SS0407E (SS1230E)		SS0507E (SS1432E)		SS0607E (SS1932E)	
	Metric	US	Metric	US	Metric	US
Working Height Max.	5.6m	18.4ft	6.3m	20.7ft	7.5m	24.6ft
A Platform Height-Raised	3.6m	11.8ft	4.3m	14.1ft	5.5m	18ft
B Platform Height-Stowed	0.95m	3.1ft	1.04m	3.4ft	1.17m	3.8ft
C Platform Length	1.35m	4.4ft	1.35m	4.4ft	1.35m	4.4ft
D Platform Width	0.7m	2.3ft	0.7m	2.3ft	0.7m	2.3ft
E Overall Length	1.53m	5ft	1.53m	5ft	1.53m	5ft
F Overall Width	0.76m	2.5ft	0.81m	2.65ft	0.81m	2.65ft
G Overall Height-Rails Up	2.06m	6.8ft	2.15m	7.1ft	2.275m	7.46ft
Overall Height-Rails Down	1.82m	6ft	1.9m	6.2ft	2m	6.56ft
H Extension Deck	0.6m	2ft	0.6m	2ft	0.6m	2ft
I Wheelbase	1.12m	44.1in	1.12m	44.1in	1.12m	44.1in
Ground Clearance(Stowed/Raised)	50/16mm	1.97/0.63in	50/16mm	1.97/0.63in	50/16mm	1.97/0.63in

PRODUCTIVITY

Platform Occupants Max. (in/out)	2/1	2/1	2/1	2/1	2/0	2/0
Platform Capacity	240kg	530lbs	230kg	510lbs	230kg	510lbs
Platform Capacity-Extension	113kg	249lbs	113kg	249lbs	113kg	249lbs
Drive Height	Full Height					
Gradeability-Stowed	25 %					
Turning Radius-Inside	0					
Turning Radius-Outside	1.5m	4.9ft	1.5m	4.9ft	1.5m	4.9ft
Raise/Lower Speed	25/20s		25/20s		32/27s	
Brakes	Front-wheel Brake					
Drive Mode	4×2					
Tires Type	Solid Non-marking					
Tires Size	230×80mm	9.1×3.1in	230×80mm	9.1×3.1in	230×80mm	9.1×3.1in

POWER

Power Source	24V DC 115Ah	24V DC 150Ah	24V DC 150Ah
--------------	--------------	--------------	--------------

HYDRAULIC SYSTEM

Hydraulic Oil Capacity	4.5L	1gal	4.5L	1gal	4.5L	1gal
------------------------	------	------	------	------	------	------

WEIGHT

Machine Weight(CE/ANSI)	880kg	1940lbs	985kg	2172lbs	1335kg	2866lbs
-------------------------	-------	---------	-------	---------	--------	---------

NEW PRODUCT

ELECTRIC MOTOR DRIVE SCISSOR LIFT

SS0407ER (SS1230ER) / SS0507ER (SS1432ER)
SS0607ER (SS1932ER)



HIGHLIGHTS

LGMG ER Series scissor lifts are equipped with an advanced maintenance free battery for better productivity with a lower service cost. This series is an ideal solution for the low-level access and space restricted application job sites. Shorter overall machine length and lighter weight makes it suitable for most elevators.

- Battery powered, zero emission and quiet drive mean this machine is environmentally friendly.
- Efficient electric drive system provides longer-lasting performance and better gradeability.
- Light weight and compact design provide better productivity with easier lifting on multi-level site applications.
- Exceptional waterproofed drive system design provides excellent performance in wet conditions.
- Commonality of control system with other electric scissor lifts.

SPECIFICATIONS

MODELS	SS0407ER (SS1230ER)		SS0507ER (SS1432ER)		SS0607ER (SS1932ER)	
	Metric	US	Metric	US	Metric	US
Working Height Max.	5.6m	18.4ft	6.6m	21.7ft	7.6m	25ft
A Platform Height-Raised	3.6m	11.8ft	4.6m	15.1ft	5.6m	18.4ft
B Platform Height-Stowed	0.86m	2.8ft	1m	3.3ft	1.1m	3.6ft
C Platform Length	1.35m	4.4ft	1.35m	4.4ft	1.35m	4.4ft
D Platform Width	0.73m	2.3ft	0.73m	2.3ft	0.73m	2.3ft
E Overall Length	1.53m	5ft	1.53m	5ft	1.53m	5ft
F Overall Width	0.76m	2.5ft	0.81m	2.65ft	0.81m	2.65ft
G Overall Height-Rails Up	2m	6.56ft	2.1m	6.87ft	2.2m	7.2ft
Overall Height-Rails Down	1.57m	5.15ft	1.66m	5.45ft	1.76m	5.77ft
H Extension Deck	0.6m	2ft	0.6m	2ft	0.6m	2ft
I Wheelbase	1.12m	44.1in	1.12m	44.1in	1.12m	44.1in
Ground Clearance(Stowed/Raised)	65/17mm	2.56/0.67in	65/17mm	2.56/0.67in	65/17mm	2.56/0.67in

PRODUCTIVITY

Platform Occupants Max. (in/out)	2/1	2/1	2/0	2/0	2/0	2/0
Platform Capacity	240kg	530lbs	230kg	510lbs	230kg	510lbs
Platform Capacity-Extension	120kg	265lbs	120kg	265lbs	120kg	265lbs
Drive Height	Full Height					
Gradeability-Stowed	25 %					
Turning Radius-Inside	0					
Turning Radius-Outside	1.46m	4.79ft	1.49m	4.89ft	1.49m	4.89ft
Raise/Lower Speed	25/18s		25/20s		32/27s	
Brakes	Front-wheel Brake					
Drive Mode	4×2					
Tires Type	Solid Non-marking					
Tires Size	250×80mm	9.8×3.1in	250×80mm	9.8×3.1in	250×80mm	9.8×3.1in

POWER

Power Source	24V DC 115Ah	24V DC 150Ah	24V DC 150Ah
--------------	--------------	--------------	--------------

HYDRAULIC SYSTEM

Hydraulic Oil Capacity	3.5L	0.8gal	3.5L	0.8gal	3.5L	0.8gal
------------------------	------	--------	------	--------	------	--------

WEIGHT

Machine Weight(CE/ANSI)	885kg	1951lbs	1040kg	2293lbs	1300kg	2866lbs
-------------------------	-------	---------	--------	---------	--------	---------

ELECTRIC MOTOR DRIVE SCISSOR LIFT

**AS0607E (AS1930E) / AS0607WE (AS1932E)
AS0608E (AS2032E) / AS0808E (AS2632E)**



HIGHLIGHTS

LGMG E Series scissor lifts provide longer battery duty cycle life with a direct electric drive system. This series can be used on a variety of construction sites, maintenance job sites and other applications, both indoor and outdoor. The wide product line from 3.6m to 13.8m platform height are perfect for different working height requirements.

- Battery powered, zero emission and quiet drive mean this machine is environmentally friendly.
- Efficient electric drive system provides longer-lasting performance and better gradeability.
- Proportional lift and drive controls deliver smoother operation.
- Swing out component trays for easy access and maintenance.
- Intelligent self-diagnostic system for quick troubleshooting.
- Commonality in parts with other electric scissor lifts.

SPECIFICATIONS

MODELS	AS0607E (AS1930E)		AS0607WE(AS1932E)		AS0608E(AS2032E)		AS0808E(AS2632E)	
Measurements	Metric	US	Metric	US	Metric	US	Metric	US
Working Height Max.	7.8m	25.6ft	7.8m	25.6ft	7.9m	25.9ft	10m	32.8ft
A Platform Height-Raised	5.8m	19ft	5.8m	19ft	5.9m	19.4ft	8m	26.2ft
B Platform Height-Stowed	1.02m	3.3ft	1.02m	3.3ft	1.03m	3.4ft	1.14m	3.7ft
C Platform Length	1.63m	5.3ft	1.63m	5.3ft	2.26m	7.4ft	2.26m	7.4ft
D Platform Width	0.74m	2.4ft	0.74m	2.4ft	0.79m	2.59ft	0.79m	2.59ft
E Overall Length	1.86m	6.1ft	1.86m	6.1ft	2.4m	7.9ft	2.4m	7.9ft
F Overall Width	0.76m	2.5ft	0.81m	2.7ft	0.83m	2.7ft	0.83m	2.7ft
G Overall Height-Rails Up	2.14m	7ft	2.14m	7ft	2.19m	7.2ft	2.32m	7.61ft
Overall Height-Rails Down	1.84m	6ft	1.84m	6ft	1.83m	6ft	1.95m	6.4ft
H Extension Deck	0.9m	3ft	0.9m	3ft	0.9m	3ft	0.9m	3ft
I Wheelbase	1.35m	53in	1.35m	53in	1.85m	73in	1.85m	73in
Ground Clearance (Stowed/Raised)	80/20mm	3.15/0.79in	80/20mm	3.15/0.79in	100/25mm	3.94/0.98in	100/25mm	3.94/0.98in

PRODUCTIVITY

Platform Occupants Max.(in/out)	2/0	2/0	2/1	2/1	2/1	2/1	2/0	2/0
Platform Capacity	230kg	510lbs	230kg	510lbs	380kg	838lbs	230kg	510lbs
Platform Capacity-Extension	120kg	265lbs	120kg	265lbs	120kg	265lbs	120kg	265lbs
Drive Height	Full Height							
Gradeability-Stowed	25 %							
Turning Radius-Inside	0							
Turning Radius-Outside	1.72m	5.6ft	1.75m	5.6ft	2.15m	7ft	2.15m	7ft
Raise/Lower Speed	16/28s	16/28s	16/28s	16/28s	30/34s	30/34s	31/40s	31/40s
Brakes	Front-wheel Brake							
Drive Mode	4×2							
Tires Type	Solid Non-marking							
Tires Size	323×100mm	12.7×4in	323×100mm	12.7×4in	380×130mm	15×5in	380×130mm	15×5in

POWER

Power Source 24V DC 225Ah

HYDRAULIC SYSTEM

Hydraulic Oil Capacity	9.5L	2.1gal	9.5L	2.1gal	13L	3.4gal	13L	3.4gal
------------------------	------	--------	------	--------	-----	--------	-----	--------

WEIGHT

Machine Weight(CE/ANSI)	1610kg	3549lbs	1620kg	3571lbs	2000kg	4409lbs	2140kg	4718lbs
-------------------------	--------	---------	--------	---------	--------	---------	--------	---------

ELECTRIC MOTOR DRIVE SCISSOR LIFT

**AS0812E (AS2646E) / AS1012E (AS3246E)
AS1212E (AS4046E)**



HIGHLIGHTS

LGMG E Series scissor lifts provide longer battery duty cycle life with its direct electric drive system. This range can be applied to various construction sites, maintenance job sites and other applications both indoor and outdoor. The wide range product line from 3.6m to 13.8m platform height can satisfy a range of different working height requirements.

- Battery powered, zero emission and quiet drive mean this machine is environmentally friendly.
- Efficient electric drive system provides longer-lasting performance and better gradeability.
- Proportional lift and drive controls deliver smoother operation.
- Swing out component trays for easy access and maintenance.
- Intelligent self-diagnostic system for quick troubleshooting.
- Commonality in parts with other electric scissor lifts.

SPECIFICATIONS

MODELS	AS0812E (AS2646E)		AS1012E (AS3246E)		AS1212E (AS4046E)	
	Metric	US	Metric	US	Metric	US
Working Height Max.	10m	32.8ft	12m	39.4ft	14m	46ft
A Platform Height-Raised	8m	26.2ft	10m	32.8ft	12m	39.4ft
B Platform Height-Stowed	1m	3.4ft	1.2m	3.9ft	1.3m	4.3ft
C Platform Length	2.26m	7.4ft	2.26m	7.4ft	2.26m	7.4ft
D Platform Width	1.12m	3.67ft	1.12m	3.67ft	1.12m	3.67ft
E Overall Length	2.42m	8ft	2.47m	8.1ft	2.47m	8.1ft
F Overall Width	1.18m	3.9ft	1.18m	3.9ft	1.18m	3.9ft
G Overall Height-Rails Up	2.3m	7.5ft	2.43m	8ft	2.56m	8.4ft
Overall Height-Rails Down	1.73m	5.7ft	1.86m	6.1ft	1.99m	6.5ft
H Extension Deck	0.9m	3ft	0.9m	3ft	0.9m	3ft
I Wheelbase	1.85m	73in	1.85m	73in	1.85m	73in
Ground Clearance (Stowed/Raised)	100/20mm	3.94/0.79in	100/20mm	3.94/0.79in	100/20mm	3.94/0.79in

PRODUCTIVITY

Platform Occupants Max. (in/out)	2/1	2/1	2/1	2/1	2/0	2/0
Platform Capacity	450kg	990lbs	320 kg	705lbs	320kg	705lbs
Platform Capacity-Extension	120kg	265lbs	120 kg	265lbs	120kg	265lbs
Drive Height	Full Height					
Gradeability-Stowed	25 %					
Turning Radius-Inside	0					
Turning Radius-Outside	2.3m	7.5ft	2.3m	7.5ft	2.3m	7.5ft
Raise/Lower Speed	35/40s	35/40s	58/48s	58/48s	58/60s	58/60s
Brakes	Front-wheel Brake					
Drive Mode	4×2					
Tires Type	Solid Non-marking					
Tires Size	380×130mm	15×5in	380×130mm	15×5in	380×130mm	15×5in

POWER

Power Source	24V DC 240Ah	24V DC 240Ah	24V DC 300Ah
--------------	--------------	--------------	--------------

HYDRAULIC SYSTEM

Hydraulic Oil Capacity	16L	4.2gal	23L	6.1gal	23L	6.1gal
------------------------	-----	--------	-----	--------	-----	--------

WEIGHT

Machine Weight(CE/ANSI)	2430kg	5357lbs	3000kg	6614lbs	3160kg	6967lbs
-------------------------	--------	---------	--------	---------	--------	---------

NEW PRODUCT

ELECTRIC SCISSOR LIFT AS1413E(AS4650E)



HIGHLIGHTS

With a platform height of 13.8m, The LGMG AS1413E greatly expands the working height of electric scissor lifts and improves the productivity for the operators in high applications.

- Efficient AC motor drive system provides longer lasting performance and better gradeability.
- 320kg capacity with 0.9m extension deck offers great productivity.
- Battery powered, zero emission and quiet drive mean this machine is environmentally friendly.
- Forklift pockets on both side and rear position for easy handling.
- Swing out component trays for easy access and maintenance.
- Intelligent self-diagnostic system for quick troubleshooting.

SPECIFICATIONS

MODELS		AS1413E (AS4650E)	
Measurements	Metric	US	
Working Height Max. (Indoor/Outdoor)	15.8/10m	51.8/32.8ft	
A Platform Height-Raised (Indoor/Outdoor)	13.8m/8m	45.3/26.2ft	
B Platform Height-Stowed	1.57m	5.15ft	
C Platform Length	2.64m	8.7ft	
D Platform Width	1.12m	3.67ft	
E Overall Length	2.8m	9.2ft	
F Overall Width	1.3m	4.3ft	
G Overall Height-Rails Up	2.74m	9ft	
Overall Height-Rails Down	1.94m	6.4ft	
H Extension Deck	0.9m	3ft	
I Wheelbase	2.22m	87.4in	
Ground Clearance(Stowed/Raised)	105/20mm	4.1/0.79in	
PRODUCTIVITY			
Platform Occupants Max. (in/out)	2/1	2/1	
Platform Capacity	320kg	705lbs	
Platform Capacity-Extension	120kg	265lbs	
Drive Height		Full Height	
Gradeability-Stowed		25 %	
Turning Radius-Inside		0	
Turning Radius-Outside	2.6m	8.5ft	
Raise/Lower Speed		85/65s	
Brakes		Front-wheel Brake	
Drive Mode		4×2	
Tires Type		Solid Non-marking	
Tires Size	380×130mm	15×5in	
POWER			
Power Source		24V DC 300Ah	
HYDRAULIC SYSTEM			
Hydraulic Oil Capacity	25.5L	6.7gal	
WEIGHT			
Machine Weight(CE/ANSI)	3570kg	7870lbs	

HYDRAULIC MOTOR DRIVE SCISSOR LIFT

AS0607 (AS1930) / AS0607W (AS1932)
AS0608 (AS2032) / AS0808 (AS2632)



HIGHLIGHTS

LGMG hydraulic motor drive scissor lifts offer industry leading reliability and simple design. They can be applied to various construction sites, maintenance job sites and other applications, both indoor and outdoor. The wide range product line from 5.8m to 13.8m platform height make these machines suitable for a wide range of requirements.

- Upgraded and reinforced design delivers better performance for various harsh conditions.
- The simple and reliable hydraulic system offers better productivity.
- Swing out component trays for easy access and maintenance.
- CAN bus system and intelligent self-diagnostic system for quick troubleshooting.
- Commonality in key parts with other scissor lifts.

SPECIFICATIONS

MODELS	AS0607 (AS1930)		AS0607W(AS1932)		AS0608(AS2032)		AS0808(AS2632)	
Measurements	Metric	US	Metric	US	Metric	US	Metric	US
Working Height Max.	7.8m	25.6ft	7.8m	25.6ft	7.9m	25.9ft	10m	32.8ft
Ⓐ Platform Height-Raised	5.8m	19ft	5.8m	19ft	5.9m	19.4ft	8m	26.2ft
Ⓑ Platform Height-Stowed	1.02m	3.3ft	1.02m	3.3ft	1.03m	3.4ft	1.14m	3.7ft
Ⓒ Platform Length	1.63m	5.3ft	1.63m	5.3ft	2.26m	7.4ft	2.26m	7.4ft
Ⓓ Platform Width	0.74m	2.4ft	0.74m	2.4ft	0.81m	2.7ft	0.81m	2.7ft
Ⓔ Overall Length	1.83m	6ft	1.83m	6ft	2.4m	7.9ft	2.4m	7.9ft
Ⓕ Overall Width	0.76m	2.5ft	0.81m	2.7ft	0.83m	2.7ft	0.83m	2.7ft
Ⓖ Overall Height-Rails Up	2.12m	7ft	2.12m	7ft	2.19m	7.2ft	2.32m	7.6ft
Overall Height-Rails Down	1.82m	6ft	1.82m	6ft	1.83m	6ft	1.95m	6.4ft
Ⓗ Extension Deck	0.9m	3ft	0.9m	3ft	0.9m	3ft	0.9m	3ft
Ⓘ Wheelbase	1.32m	52in	1.32m	52in	1.85m	73in	1.85m	73in
Ground Clearance (Stowed/Raised)	60/20mm	2.36/0.79in	60/20mm	2.36/0.79in	100/25mm	3.94/0.98in	100/25mm	3.94/0.98in

PRODUCTIVITY

Platform Occupants Max.(in/out)	2/0	2/0	2/1	2/1	2/1	2/1	2/0	2/0
Platform Capacity	230kg	510lbs	230kg	510lbs	380kg	838lbs	230kg	510lbs
Platform Capacity-Extension	120kg	265lbs	120kg	265lbs	120kg	265lbs	120kg	265lbs
Drive Height	Full Height							
Gradeability-Stowed	25 %							
Turning Radius-Inside	0							
Turning Radius-Outside	1.65m	5.4ft	1.65m	5.4ft	2.15m	7ft	2.15m	7ft
Raise/Lower Speed	16/28s		16/28s		30/34s		31/40s	
Brakes	Rear-wheel Brake							
Drive Mode	4×2							
Tires Type	Solid Non-marking							
Tires Size	305×114mm	12×4.5in	305×114mm	12×4.5in	380×130mm	15×5in	380×130mm	15×5in

POWER

Power Source 24V DC 225Ah

HYDRAULIC SYSTEM

Hydraulic Oil Capacity	9.5L	2.1gal	9.5L	2.1gal	13L	3.4gal	13L	3.4gal
------------------------	------	--------	------	--------	-----	--------	-----	--------

WEIGHT

Machine Weight(CE/ANSI)	1580kg	3483lbs	1600kg	3527lbs	2000kg	4409lbs	2140kg	4718lbs
-------------------------	--------	---------	--------	---------	--------	---------	--------	---------

HYDRAULIC MOTOR DRIVE SCISSOR LIFT

AS0812 (AS2646) / AS1012 (AS3246)
AS1212 (AS4046) / AS1413 (AS4650)



HIGHLIGHTS

LGMG hydraulic motor drive scissor lifts offer industry leading reliability and simple design. They can be applied to various construction sites, maintenance job sites and other applications, both indoor and outdoor. The wide range product line from 5.8m to 13.8m platform height make these machines suitable for a wide range of requirements.

- Upgraded and reinforced design delivers better performance for various harsh conditions.
- The simple and reliable hydraulic system offers better productivity.
- Swing out component trays for easy access and maintenance.
- CAN bus system and intelligent self-diagnostic system for quick troubleshooting.
- Commonality in key parts with other scissor lifts.

SPECIFICATIONS

MODELS	AS0812(AS2646)		AS1012(AS3246)		AS1212(AS4046)		AS1413(AS4650)	
Measurements	Metric	US	Metric	US	Metric	US	Metric	US
Working Height Max.	10m	32.8ft	12m	39.4ft	14m	46ft	15.8/10m	51.8/32.8ft
Ⓐ Platform Height-Raised	8m	26.2ft	10m	32.8ft	12m	39.4ft	13.8/8m	45.3/26.2ft
Ⓑ Platform Height-Stowed	1m	3.4ft	1.2m	3.9ft	1.3m	4.3ft	1.6m	5.25ft
Ⓒ Platform Length	2.26m	7.4ft	2.26m	7.4ft	2.26m	7.4ft	2.64m	8.7ft
Ⓓ Platform Width	1.15m	3.8ft	1.15m	3.8ft	1.15m	3.8ft	1.15m	3.8ft
Ⓔ Overall Length	2.42m	8ft	2.47m	8ft	2.47m	8ft	2.8m	9.2ft
Ⓕ Overall Width	1.18m	3.9ft	1.18m	3.9ft	1.18m	3.9ft	1.3m	4.3ft
Ⓖ Overall Height-Rails Up	2.3m	7.5ft	2.43m	8ft	2.56m	8.4ft	2.74m	9ft
Overall Height-Rails Down	1.73m	5.7ft	1.86m	6.1ft	1.99m	6.5ft	2.16m	7.1ft
Ⓗ Extension Deck	0.9m	3ft	0.9m	3ft	0.9m	3ft	0.9m	3ft
Ⓘ Wheelbase	1.85m	73in	1.85m	73in	1.85m	73in	2.22m	87.4in
Ground Clearance (Stowed/Raised)	100/20mm	3.94/0.79in	100/20mm	3.94/0.79in	100/20mm	3.94/0.79in	105/20mm	4.1/0.79in

PRODUCTIVITY

Platform Occupants Max.(in/out)	2/1	2/1	2/1	2/1	2/0	2/0	2/1	2/1
Platform Capacity	450kg	990lbs	320kg	705lbs	320kg	705lbs	320kg	705lbs
Platform Capacity-Extension	120kg	265lbs	120kg	265lbs	120kg	265lbs	120kg	265lbs
Drive Height	Full Height							
Gradeability-Stowed	25 %							
Turning Radius-Inside	0							
Turning Radius-Outside	2.3m	7.5ft	2.3m	7.5ft	2.3m	7.5ft	2.85m	9.4ft
Raise/Lower Speed	35/40 s		58/48 s		65/60 s		85/65 s	
Brakes	Front-wheel Brake							
Drive Mode	4×2							
Tires Type	Solid Non-marking							
Tires Size	380×130mm	15×5in	380×130mm	15×5in	380×130mm	15×5in	380×130mm	15×5in

POWER

Power Source	24V DC 240Ah	24V DC 240Ah	24V DC 300Ah	24V DC 300Ah
--------------	--------------	--------------	--------------	--------------

HYDRAULIC SYSTEM

Hydraulic Oil Capacity	16L	4.2gal	23L	6.1gal	23L	6.1gal	25.5L	6.7gal
------------------------	-----	--------	-----	--------	-----	--------	-------	--------

WEIGHT

Machine Weight(CE/ANSI)	2360kg	5203lbs	3000kg	6614lbs	3160kg	6967lbs	3570kg	7870lbs
-------------------------	--------	---------	--------	---------	--------	---------	--------	---------

NEW PRODUCT

ELECTRIC RT SCISSOR LIFT

SR1018E (SR3369E)

SR1218E (SR4069E)



HIGHLIGHTS

LGMG SR18E Series rough terrain scissor lifts deliver a large platform, high capacity and environmentally friendly solutions for both indoor and outdoor applications. A compact design, battery powered together with oscillating axles provides flexibility for the machine to work on both firm level and rough terrain environments.

- High capacity, large platform with compact design maximizes productivity.
- Battery powered, zero emission and quiet drive mean this machine is environmentally friendly.
- Equipped with oscillating axles that provide excellent performance in soft and rough terrain conditions.
- Optional hydraulic outriggers deliver a better solution on uneven ground.
- Intelligent self-diagnostic system for quick troubleshooting.

SPECIFICATIONS

MODELS	SR1018E (SR3369E)		SR1218E (SR4069E)	
Measurements	Metric	US	Metric	US
Working Height Max.	11.7m	38.4ft	13.9m	45.9ft
A Platform Height-Raised	9.7m	31.8ft	11.9m	39ft
B Platform Height-Stowed	1.41m	4.62ft	1.56m	5.12ft
C Platform Length	2.79m	9.15ft	2.79m	9.15ft
D Platform Width	1.6m	5.25ft	1.6m	5.25ft
E Overall Length	3.12m	10.2ft	3.12m	10.2ft
F Overall Width	1.79m	5.81ft	1.79m	5.81ft
G Overall Height-Rails Up	2.55m	8.36ft	2.7m	8.86ft
Overall Height-Rails Down	1.89m	6.2ft	2.04m	6.69ft
Extension Deck	1.52m	4.99ft	1.52m	4.99ft
H Wheelbase	2.29m	75.1in	2.29m	75.1in
Ground Clearance-Center	0.23m	0.75ft	0.23m	0.75ft

PRODUCTIVITY

Platform Occupants Max. (in/out)	4/2	4/2	3/2	3/2
Platform Capacity	454kg	998.8lbs	365kg	803lbs
Platform Capacity-Extension	140kg	308lbs	140kg	308lbs
Drive Height	Full Height			
Gradeability-Stowed	35%			
Turning Radius-Outside	4.75m	15.6ft	4.75m	15.6ft
Raise/Lower Speed	39/46s		61/55s	
Brakes	Rear-wheel Brake			
Drive Mode	4×2			
Tires Type	Foam-filled Non-marking			
Tires Size	663×283mm	26×12in	663×283mm	26×12in

POWER

Power Source	48V DC 315Ah			
Fuel Tank Capacity	/			

HYDRAULIC SYSTEM

Hydraulic Oil Capacity	70L	18.5gal	70L	18.5gal
------------------------	-----	---------	-----	---------

WEIGHT

Machine Weight without Outriggers(CE/ANSI)	3950kg	8690lbs	5100kg	11220lbs
Machine Weight with Outriggers(Optional)	4410kg	9720lbs	5560kg	12260lbs

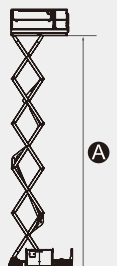
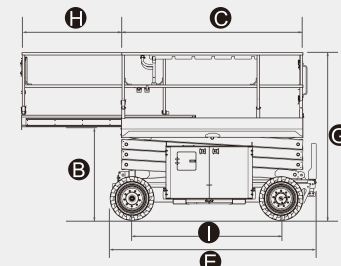
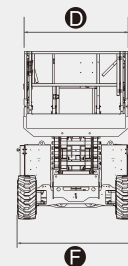

NEW PRODUCT

DIESEL RT SCISSOR LIFT

SR1018D (SR3369D)

SR1218D (SR4069D)



HIGHLIGHTS

LGMG SR18D Series rough terrain scissor lifts are specifically built for tough construction sites with four-wheel drive and fantastic gradeability. High load capacities with compact design provide a great combination for the larger working area and greater maneuverability through rough terrain job sites.

- High capacity, large platform with compact design maximises productivity.
- Powerful diesel engine and four-wheel drive make the machine ideal for varying conditions.
- Oscillating axels with great gradeability provide better performance on rough terrain job sites.
- Optional hydraulic outriggers deliver better stability on uneven ground.
- Intelligent self-diagnostic system for quick troubleshooting.

SPECIFICATIONS

MODELS	SR1018D (SR3369D)		SR1218D (SR4069D)	
Measurements	Metric	US	Metric	US
Working Height Max.	11.7m	38.4ft	13.9m	45.6ft
A Platform Height-Raised	9.7m	31.8ft	11.9m	39ft
B Platform Height-Stowed	1.41m	4.62ft	1.56m	5.12ft
C Platform Length	2.79m	9.15ft	2.79m	9.15ft
D Platform Width	1.6m	5.25ft	1.6m	5.25ft
E Overall Length	3.12m	10.2ft	3.12m	10.2ft
F Overall Width	1.79m	5.81ft	1.79m	5.81ft
G Overall Height-Rails Up	2.55m	8.36ft	2.7m	8.86ft
Overall Height-Rails Down	1.89m	6.2ft	2.04m	6.69ft
Extension Deck	1.52m	4.99ft	1.52m	4.99ft
H Wheelbase	2.29m	75.1in	2.29m	75.1in
Ground Clearance-Center	0.23m	0.75ft	0.23m	0.75ft

PRODUCTIVITY

Platform Occupants Max. (in/out)	4/2	4/2	3/2	3/2
Platform Capacity	454kg	998.8lbs	365kg	803lbs
Platform Capacity-Extension	140kg	308lbs	140kg	308lbs
Drive Height	Full Height			
Gradeability-Stowed	35%			
Turning Radius-Outside	4.75m	15.6ft	4.75m	15.6ft
Raise/Lower Speed	39/46s		61/55s	
Brakes	Four-wheel Brake			
Drive Mode	4×4			
Tires Type	Foam-filled			
Tires Size	663×283mm	26×12in	663×283mm	26×12in

POWER

Power Source	Kubota D1105 18.5kw/24.8hp			
Fuel Tank Capacity	53L	14gal	53L	14gal

HYDRAULIC SYSTEM

Hydraulic Oil Capacity	70L	18.5gal	70L	18.5gal
------------------------	-----	---------	-----	---------

WEIGHT

Machine Weight without Outriggers(CE/ANSI)	3950kg	8710lbs	4900kg	10780lbs
Machine Weight with Outriggers(Optional)	4410kg	9720lbs	5360kg	11820lbs

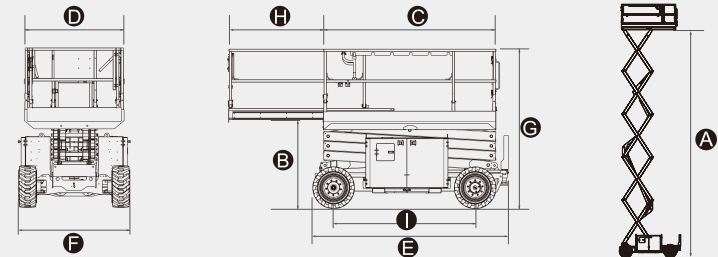

DIESEL RT SCISSOR LIFT

SR1023D (SR3390D) / SR1323D (SR4390D)
SR1623D (SR5390D)



HIGHLIGHTS

LGMG SR23D Series rough terrain scissor lifts deliver higher capacities and larger platforms for the most tough construction job sites. Four-wheel drive, oscillating axels and hydraulic outriggers provide superior stability on the most tough uneven surfaces.

- Larger working platform with dual extension decks offers great productivity.
- Powerful diesel engine, oscillating axels and four-wheel drive provide better performance on most rough terrain job sites.
- Standard features with one button auto leveling outriggers, overload system, motion alarm, help the operator to complete the job in a much safer way.
- Pull-out engine tray for easy access and maintenance.
- On-board self-diagnosis system makes it easier for quick troubleshooting.

SPECIFICATIONS

MODELS	SR1023D(SR3390D)		SR1323D (SR4390D)		SR1623D (SR5390D)	
Measurements	Metric	US	Metric	US	Metric	US
Working Height Max.	12m	39.4ft	15m	49.2ft	17.9m	58.7ft
A Platform Height-Raised	10m	32.8ft	13m	42.65ft	15.9m	52.2ft
B Platform Height-Stowed	1.58m	62ft	1.83m	72ft	2.08m	81.9ft
C Platform Length	3.98m	13ft	3.98m	13ft	3.98m	13ft
D Platform Width	1.83m	6ft	1.83m	6ft	1.83m	6ft
E Overall Length	4.9m	16ft	4.9m	16ft	4.9m	16ft
F Overall Width	2.3m	7.55ft	2.3m	7.55ft	2.3m	7.55ft
G Overall Height-Rails Up	2.74m	8.99ft	2.96m	9.71ft	3.18m	10.45ft
Overall Height-Rails Down	2.06m	6.75ft	2.28m	7.48ft	2.5m	8.2ft
Extension Deck (Front/Rear)	1.45/1.14m	4.75/3.7ft	1.45/1.14m	4.75/3.7ft	1.45/1.14m	4.75/3.7ft
H Wheelbase	2.85m	111.2in	2.85m	111.2in	2.85m	111.2in
Ground Clearance(Ground Clearance-Center)	0.23m	0.75ft	0.23m	0.75ft	0.23m	0.75ft

PRODUCTIVITY

Platform Occupants Max. (In/out)	7/7	7/7	7/7	7/7	4/4	4/4
Platform Capacity	1100kg	2430lbs	910kg	2010lbs	680kg	1500lbs
Platform Capacity-Extension	230kg	510lbs	230kg	510lbs	230kg	510lbs
Drive Height	10m	32.8ft	8.5m	27.9ft	8.5m	27.9ft
Gradeability-Stowed	40%					
Turning Radius-Outside	5.33m	17.45ft	5.33m	17.45ft	5.33m	17.45ft
Raise/Lower Speed	45/45s		55/55s		55/55s	
Brakes	Four-wheel Brake					
Drive Mode	4×4					
Tires Type	Solid					
Tires Size	835×290mm	33×12in	835×290mm	33×12in	835×290mm	33×12in

POWER

Power Source	Deutz D2.9 L4 36.4kw/48.8hp					
Fuel Tank Capacity	110L	30gal	110L	30gal	110L	30gal

HYDRAULIC SYSTEM

Hydraulic Oil Capacity	140L	37gal	140L	37gal	140L	37gal
------------------------	------	-------	------	-------	------	-------

WEIGHT

Machine Weight(6.58m platform,CE/ANSI)	6880kg	15170lbs	7360kg	16230lbs	8100kg	17860lbs
Machine Weight(7.4m platform,CE/ANSI)	6980kg	15400lbs	7460kg	16450lbs	8200kg	18080lbs

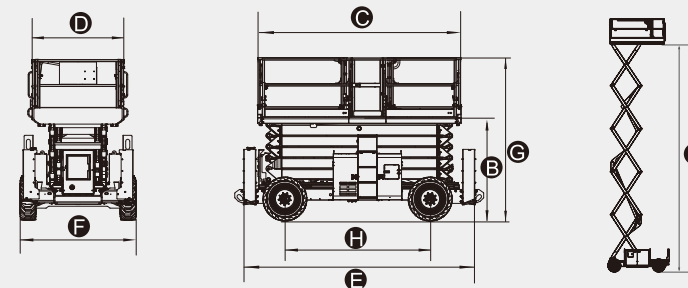

ARTICULATING BOOM LIFT

A14JE(A45JE)

SPECIFICATIONS



HIGHLIGHTS

LGMG A14JE electric articulating boom lifts provide environmentally friendly, zero emission operation for both indoor and outdoor applications. Up to 13.8m platform height with 1.5m standard jib, A14JE offers great ability to extend over obstacles in tight working areas.

- Zero tail swing and compact design enables easy access to tight spaces.
- Proportional control ensures smooth driving, precise positioning and comfortable operation.
- Battery powered and sealed AC drive motor provides quiet and long battery duty cycle.
- Self-leveling platform together with hydraulic platform rotation deliver exceptional productivity.
- Intelligent self-diagnostic system for quick troubleshooting.

MODELS

A14JE (A45JE)

Measurements	Metric	US
Working Height Max.	15.8m	51.8ft
Platform Height	13.8m	45.3ft
Horizontal Outreach	7.81m	25.6ft
Up and Over Height	7.26m	23.8ft
A Stowed Length	6.66m	21.9ft
B Stowed Width	1.8m	5.9ft
C Stowed Height	1.98m	6.5ft
D Platform Length	1.83m	5.9ft
E Platform Width	0.76m	2.6ft
Platform Capacity	230kg	510lbs
Wheelbase	2.03m	80in
Ground Clearance	0.24m	0.79ft

PRODUCTIVITY

Platform Occupants Max. (In/out)	2/2	
Drive Speed-Stowed	4.8km/h	3mph
Drive Speed-Raised	1km/h	0.62mph
Gradeability-Stowed	30%	
Platform Rotator	160°	
Turnable Rotation	355°	
Turnable Tailswing	0	
Turning Radius-Inside	1.83m	6ft
Turning Radius-Outside	4.1m	13.5ft
Tires Type	Foam-filled non marking	
Tires Size	719×246mm	28.3×9.7in

POWER

power source	48V DC 390Ah	
Fuel Tank Capacity	\	

HYDRAULIC SYSTEM

Hydraulic Oil Capacity	30L	7.9gal
------------------------	-----	--------

WEIGHT

Machine Weight(CE/ANSI)	7500kg	16535lbs
-------------------------	--------	----------

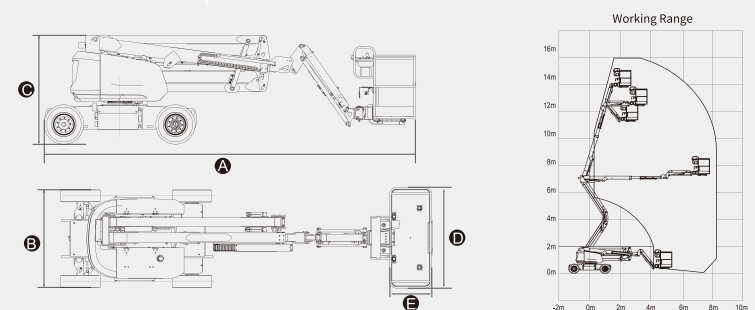

COMING SOON

ARTICULATING BOOM LIFT

AR14J(AR45J) / AR16J(AR52J)



HIGHLIGHTS

LGMG AR Series articulating boom lifts are purpose built for outdoor construction and industrial applications. Simple and reliable design with industrial features make this machine easy to operate. A standard job offers the ability to reach even the most hard to reach places.

- Oscillating axels and four-wheel drive delivers better gradeability on rough terrain.
- Proportional smooth driving, precise positioning and comfortable operation.
- Self-leveling platform together with hydraulic platform rotation deliver exceptional productivity.
- Swing out engine tray for easy access and maintenance.
- Intelligent self-diagnostic system for quick troubleshooting.

SPECIFICATIONS

MODELS	AR14J (AR45J)		AR16J (AR52J)	
Measurements	Metric	US	Metric	US
Working Height Max.	16.09m	52.79ft	17.70m	58.1ft
Platform Height	14.09m	46.23ft	15.7m	51.5ft
Horizontal Outreach	7.67m	25.16ft	9.39m	30.8ft
Up and Over Height	7.56m	24.8ft	7.56m	24.8ft
A Stowed Length	6.7m	22.2ft	7.56m	24.8ft
B Stowed Width	2.31m	7.58ft	2.31m	7.58ft
C Stowed Height	2.17m	7.1ft	2.17m	7.1ft
D Platform Length	1.83m	5.9ft	1.83m	5.9ft
E Platform Width	0.76m	2.6ft	0.76m	2.6ft
Platform Capacity	230kg	510lbs	230kg	510lbs
Wheelbase	2.059m	81in	2.059m	81in
Ground Clearance	0.36m	1.18ft	0.36m	1.18ft

PRODUCTIVITY

Platform Occupants Max. (in/out)	2/2		2/2	
Drive Speed-Stowed	6.1km/h	3.8mph	6.1km/h	3.8mph
Drive Speed-Raised	0.8km/h	0.5mph	0.8km/h	0.5mph
Gradeability-Stowed	30%		30%	
Platform Rotator	160°		160°	
Turnable Rotation	355°		355°	
Turnable Tailswing	0		0	
Turning Radius-Inside	1.94m	6.36ft	1.94m	6.36ft
Turning Radius-Outside	4.41m	14.47ft	4.41m	14.47ft
Tires Type	RT Foam-filled		RT Foam-filled	
Tires Size	848×315mm	33.4×12.4in	848×315mm	33.4×12.4in

POWER

power source	Deutz EU V Tier 4f 36.4kw/48.8hp			
Fuel Tank Capacity	65L	17.2gal	65L	17.2gal

HYDRAULIC SYSTEM

Hydraulic Oil Capacity	130L	34.3gal	130L	34.3gal
------------------------	------	---------	------	---------

WEIGHT

Machine Weight(CE/ANSI)	7160kg	15785lbs	8180kg	18034lbs
-------------------------	--------	----------	--------	----------

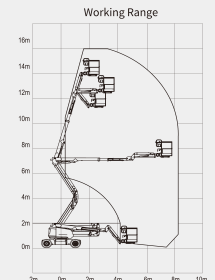
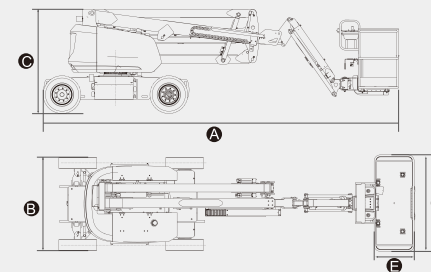

COMING SOON

TELESCOPIC BOOM LIFT T20J(T65J) / T26J(T85J)



HIGHLIGHTS

LGMG T Series telescopic boom lifts offer great outreach with high working efficiency. Its exceptional all terrain capacities allow the machine to operate on the roughest ground and complete the tasks on time.

- Oscillating axels and four-wheel drive delivers better gradeability on rough terrain.
- Proportional control ensures smooth driving, precise positioning and comfortable operation.
- Continuous 360° rotation expands the operational area and makes operations more convenient.
- Swing out engine tray for easy access and maintenance.
- Intelligent self-diagnostic system for quick troubleshooting.

SPECIFICATIONS

MODELS	T20J (T65J)		T26J (T85J)	
Measurements	Metric	US	Metric	US
Working Height Max.	21.7m	71.2ft	27.9m	91.5ft
Platform Height	19.7m	64.6ft	25.9m	84.9ft
Horizontal Outreach	17.2m	56.4ft	23.32m	76.5ft
Below Ground Reach	2.72m	8.92ft	2.89m	9.48ft
Platform Length	1.83m	71in	2.44m	96in
Platform Width	0.76m	30in	0.91m	36in
Platform Capacity	250kg	551lbs	250/340kg	551/750lbs
A Stowed Length	9.47m	31.07ft	12.6m	41.3ft
B Overall Width	2.495m	8.186ft	2.5m	8.2ft
C Stowed Height	2.77m	9.09ft	2.86m	9.38ft
D Wheelbase	2.51m	8.24ft	2.85m	9.35ft
E Ground Clearance	0.395m	1.296ft	0.44m	1.44ft
PRODUCTIVITY				
Platform Occupants Max.(in/out)	2/2	2/2	2/2	2/2
Turntable Rotation	360°Continuous		360°Continuous	
Turntable Tailswing	1.22m	4ft	1.42m	4.66ft
Drive Speed-Stowed	4.8km/h	3mph	4.8km/h	3mph
Drive Speed-Raised	0.8km/h	0.5mph	0.8km/h	0.5mph
Gradeability	45%		45%	
Max. Wind Speed	12.5m/s	28mph	12.5m/s	28mph
Turning Radius-Inside	2.5m	8.2ft	3.66m	12ft
Turning Radius-Outside	5.5m	18ft	6.55m	21.5ft
Max.Slope	2.5/4.5°		2.5/4.5°	
Tire type	RT Foam-filled		RT Foam-filled	
Tires	355/55D 625		18-625	
POWER				
power source	Deutz D 2.9L4 36.4kw/48.8hp		Deutz TD 2.9L4 55.4kw/74.3hp	
Fuel Tank Capacity	100L	26.4gal	100L	26.4gal
HYDRAULIC SYSTEM				
Hydraulic Oil Capacity	180L	47.5gal	180L	47.5gal
WEIGHT				
Machine Weight(CE/ANSI)	11400kg	25132lbs	18000kg	39683lbs

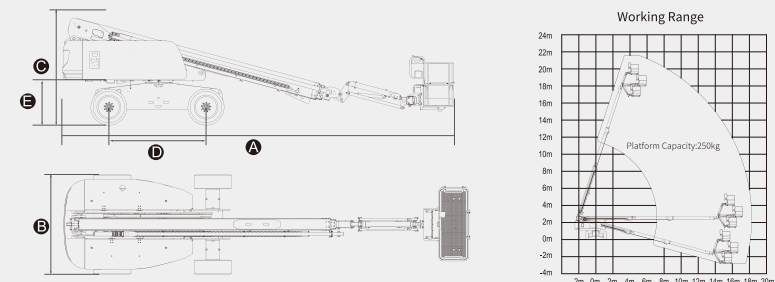



APPLICATIONS

LGMG products are used widely in industrial factories, industrial construction, road and bridge construction, aviation, shipyards and other applications.

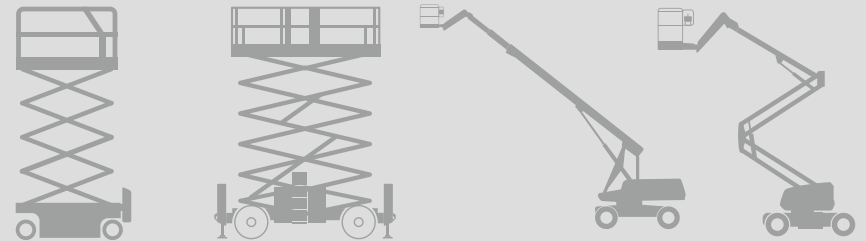

SERVICE

LGMG provides technical support, training programs, warranty and parts sales to customers during the whole machine life-cycle.



Technical support

LGMG service teams always provide remote technical support by phone or email and even on-site support with manuals, tools, information and service solutions.



Training support

LGMG provides various training programs to the operators and service technicians, helping rental companies to improve their service and training ability via dedicated courses prepared by LGMG teams either online or on-site.



Warranty and parts support

LGMG provides sufficient stock of parts both in LGMG HQ and LGMG Europe/NA locations. Accurate parts manuals and technical support teams are always available to answer your questions.

