



RX 20 Technical Data.

Electric forklift trucks.

RX 20-15

RX 20-16

RX 20-18

RX 20-20



This specification sheet to VDI Guideline 2198 only gives the technical figures for the standard truck.
Different tyres, other masts, additional equipment etc. could give different figures.

Characteristics	1.1	Manufacturer		STILL	STILL	STILL	STILL		
	1.2	Manufacturer's model designation		RX 20-15	RX 20-16	RX 20-16P	RX 20-18		
	1.3	Power supply - electric, diesel, petrol, gas, mains electric		Electric	Electric	Electric	Electric		
	1.4	Type of control - hand, pedestrian, stand-on, rider seated		Rider seated	Rider seated	Rider seated	Rider seated		
	1.5	Carrying capacity/load	Q	kg	1500	1600	1600	1800	
	1.6	Load centre	c	mm	500	500	500	500	
Weights	1.8	Load distance	x	mm	350	355	355	355	
	1.9	Wheelbase	y	mm	1341	1341	1410	1441	
	2.1	Weight		kg	2824	2884	2916	3044	
	2.2	Axle loadings laden front		kg	3743	3933	3915	4288	
	2.2.1	Axle loadings laden rear		kg	513	550	602	556	
Wheels Chassis	2.3	Axle loadings unladen front		kg	1292	1314	1345	1421	
	2.3.1	Axle loadings unladen rear		kg	1464	1570	1571	1623	
	3.1	Tyres - rubber (V), superelastic (SE), pneumatic (L), polyurethane (PE)			SE	SE	SE	SE	
	3.2	Tyre size - front			18 x 7-8	18 x 7-8	18 x 7-8	200/50-10	
	3.3	Tyre size - rear			15 x 4 1/2 -8	15 x 4 1/2 -8	16 x 6-8	15 x 4 1/2 -8	
	3.5	Wheels - number front (x = drive wheel)			2x	2x	2x	2x	
	3.5.1	Wheels - number rear (x = drive wheel)			2	2	2	2	
	3.6	Track width - front	b ₁₀	mm	932	932	932	942	
	3.7	Track width - rear	b ₁₁	mm	168	168	865	168	
	Basic dimensions	4.1	Tilt angle, mast/fork carriage forwards		°	3	3	3	3
		4.1.1	Tilt angle, mast/fork carriage backwards		°	8	8	8	8
		4.2	Closed height	h ₁	mm	2160	2160	2160	2160
		4.3	Free lift	h ₂	mm	150	150	150	150
4.4		Lift height	h ₃	mm	3230	3230	3230	3230	
4.5		Height, mast raised	h ₄	mm	3805	3805	3805	3805	
4.7		Height to top of overhead guard (cabin)	h ₆	mm	2082	2082	2082	2082	
4.8		Seat height	h ₇	mm	1015	1015	1015	1015	
4.12		Coupling height	h ₁₀	mm	490	490	460/350	490	
4.19		Overall length	l ₁	mm	2683	2683	2861	2783	
4.20		Length to front face of forks	l ₂	mm	1883	1883	2061	1983	
4.21		Overall width	b ₁	mm	1099	1099	1099	1138	
4.22		Fork thickness	s	mm	35	40	40	40	
4.22.1		Fork width	e	mm	80	80	80	80	
4.22.2		Fork length	l	mm	800	800	800	800	
4.23		Fork carriage to ISO 2328 - class/form A or B			ISO II/A	ISO II/A	ISO II/A	ISO II/A	
Performance data		4.24	Fork carriage width	b ₃	mm	980	980	980	980
	4.31	Ground clearance beneath mast, laden	m ₁	mm	90	90	90	90	
	4.32	Ground clearance at centre of wheelbase	m ₂	mm	123	123	123	123	
	4.33	Aisle width for pallets 1000 x 1200 wide	A _{st}	mm	3204	3209	3408	3309	
	4.34	Aisle width for pallets 800 x 1200 long	A _{st}	mm	3328	3333	3607	3433	
	4.35	Outer turning radius	W _a	mm	1523	1528	1852	1628	
	4.36	Inner turning radius	b ₁₃	mm	-	-	533	-	
	5.1	Speed laden		km/h	16	16	16	16	
	5.1.1	Speed unladen		km/h	16	16	16	16	
	5.2	Lift speed laden		m/s	0.43	0.43	0.43	0.42	
	5.2.1	Lift speed unladen		m/s	0.60	0.60	0.60	0.60	
	5.3	Lowering speed laden		m/s	0.51	0.51	0.51	0.52	
5.3.1	Lowering speed unladen		m/s	0.47	0.47	0.47	0.48		
5.5	Rated drawbar pull laden		N	3200	3200	3200	3050		
5.5.1	Rated drawbar pull unladen		N	3340	3340	3340	3320		
5.6	Max. drawbar pull laden		N	9260	9260	9250	8990		
5.6.1	Max. drawbar pull unladen		N	9120	9120	9120	9130		
5.7	Gradeability laden		%	12.8	12.8	12.7	11.4		
5.7.1	Gradeability unladen		%	20.1	20.1	19.9	19.0		
5.8	Max. gradeability laden		%	21.2	21.2	21.0	19.0		
5.8.1	Max. gradeability unladen		%	24.8	24.8	25.4	25.9		
5.9	Acceleration time laden		s	4.1	4.1	4.1	4.2		
5.9.1	Acceleration time unladen		s	4.0	4.0	4.0	4.0		
5.10	Brakes			elect./mech.	elect./mech.	elect./mech.	elect./mech.		
E-Motor	6.1	Drive motor hourly capacity		kW	2x4.5	2x4.5	2x4.5	2x4.5	
	6.2	Hoist motor capacity at 20% duty factor		kW	9	9	9	9	
	6.3	Battery equipment to DIN 43531/35/36 A, B, C, no			DIN 43531 B	DIN 43531 B	DIN 43531 B	DIN 43531 B	
	6.4	Battery voltage	U	V	48	48	48	48	
	6.4.1	Battery capacity	K 5	Ah	575L	575L	575L	575L	
	6.5	Battery weight		kg	856	856	856	856	
6.6	Energy consumption 60 VDI work cycles/hour		kWh/h	4.3	4.4	4.4	4.7		
Miscellaneous	8.1	Drive control							
	8.2	Operating pressure for attachments		bar	250	250	250	250	
	8.3	Oil flow for attachments		l/min	30	30	30	30	
	8.4	Average noise peak at operator's ears		dB(A)	<70	<70	<70	<70	
	8.5	Trailer coupling, type/DIN			Bolt	Bolt	Bolt	Bolt	

STILL	STILL	STILL	STILL
RX 20-18P/h	RX 20-20	RX 20-20 P	RX 20-20 P/h
Electric	Electric	Electric	Electric
Rider seated	Rider seated	Rider seated	Rider seated
1800	2000	2000	2000
500	500	500	500
355	365	365	365
1448	1540	1469	1448
3343	3212	3225	3453
4442	4667	4633	4888
701	545	592	565
1580	1544	1455	1693
1763	1668	1770	1760
SE	SE	SE	SE
200/50-10	200/50-10	200/50-10	200/50-10
16 x 6-8	15 x 4 1/2 -8	16 x 6-8	16 x 6-8
2x	2x	2x	2x
2	2	2	2
942	942	942	942
865	168	865	865
3	3	3	3
8	8	8	8
2160	2160	2160	2160
150	150	150	150
3230	3150	3150	3150
3805	3805	3805	3805
2240	2082	2082	2240
1173	1015	1015	1173
460/350	490	460/350	460/350
2908	2892	2930	2918
2108	2092	2130	2118
1138	1138	1138	1138
40	40	40	40
80	80	80	80
800	800	800	800
ISO II/A	ISO II/A	ISO II/A	ISO II/A
980	980	980	980
90	90	90	90
123	123	123	123
3439	3418	3473	3449
3638	3542	3672	3648
1883	1727	1907	1883
538.5	-	541	538.5
16	16	16	16
16	16	16	16
0.42	0.38	0.38	0.38
0.60	0.52	0.52	0.52
0.52	0.53	0.53	0.53
0.48	0.49	0.49	0.49
2980	2980	2970	2930
3260	3280	3280	3240
8950	8950	8950	8920
9080	9100	9070	9070
10.7	10.5	10.5	10
17.1	17.9	17.8	16.5
17.8	17.6	17.5	16.7
26.4	27.2	25.2	27.2
4.3	4.3	4.3	4.4
4.1	4.1	4.1	4.2
elect./mech.	elect./mech.	elect./mech.	elect./mech.
2x4.5	2x4.5	2x4.5	2x4.5
9	9	9	9
DIN 43531 B	DIN 43531 B	DIN 43531 B	DIN 43531 B
48	48	48	48
700L	575L	575L	700L
1119	856	856	1119
5.2	5.0	5.0	5.4
250	250	250	250
30	30	30	30
<70	<70	<70	<70
Bolt	Bolt	Bolt	Bolt

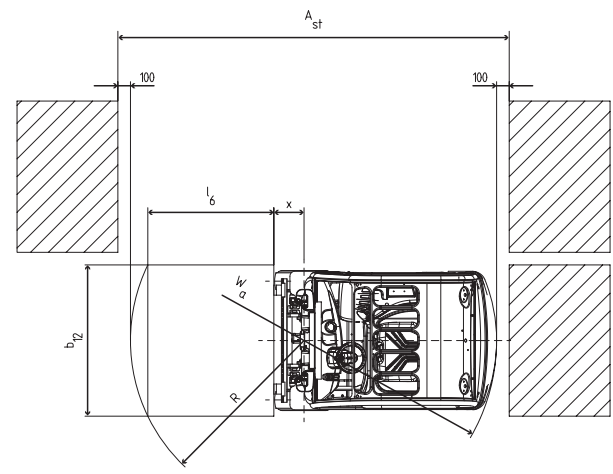
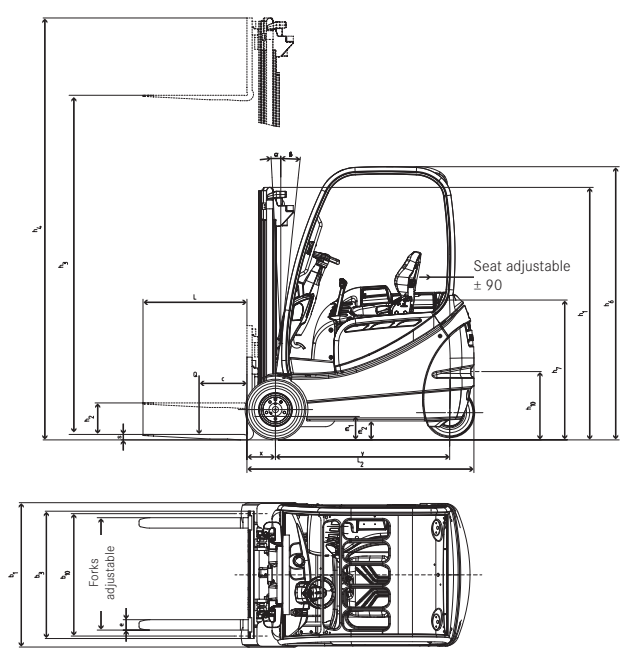

Dimensions relate to a vertical mast

				Telescopic-mast		HiLo - mast		Triplex - mast		
RX 20-15/16	Rated lift	h ₃	mm	2830 - 4230	4730 - 5430	2975 - 3975	4320 - 5220	5620 - 7870		
	Closed height	h ₁	mm	1960 - 2660	2910 - 3260	1960 - 2460	1960 - 2260	2460 - 3210		
	Free lift Form "B"	h ₂ /h ₅	mm	150	150	1330 - 1830	1330 - 1630	1830 - 2580		
	Free lift Form "A"	h ₂ /h ₅	mm	150	150	1362 - 1862	1362 - 1662	1862 - 2612		
	Overall height raised Form "B"	h ₄	mm	3480 - 4880	5280 - 6080	3625 - 4625	4970 - 5870	6270 - 8520		
	Overall height raised Form "A"	h ₄	mm	3473 - 4873	5273 - 6073	3593 - 4593	4938 - 5838	6238 - 8488		
	Forward tilt	a	°	3						
	Back tilt	b	°	8		6				
	Fork location centre - centre		mm	216 368 445 521 673 670						
	Greatest width	B	mm	1099	1188	1099	1099	1188		
	Overall length	L ₂	mm	1883			1903			
	Load distance	x	mm	355			375			
	Working aisle width	A _{st}	mm	(1000 x 1200) 3209 (1200 x 800) 3333			(1000 x 1200) 3228 (1200 x 800) 3353			
	Tyres	v		18 x 7 - 8	200/50-10	18 x 7 - 8	18 x 7 - 8	200/50-10		
Tyres	h		15 x 4 1/2 - 8							
Track	v/h	mm	932/168	990/168	932/168	932/168	990/168			
RX 20-16P	Overall length	L ₂	2061			2081				
	Working aisle width	A _{st}	(1000 x 1200) 3408 (1200 x 800) 3607			(1000 x 1200) 3428 (1200 x 800) 3627				
	Tyres	v/h	18 x 7 - 8 / 16 x 6 - 8							
	Track	v/h	932/865	990/865	932/865	932/865	990/865			
RX 20-18	Rated lift	h ₃	mm	2830 - 4230	4730 - 5430	2875 - 3875	4170 - 5070	5470 - 7720		
	Closed height	h ₁	mm	1960 - 2660	2910 - 3260	1960 - 2460	1960 - 2260	2460 - 3210		
	Free lift Form "B"	h ₂ /h ₅	mm	150	150	1312 - 1812	1312 - 1612	1812 - 2562		
	Free lift Form "A"	h ₂ /h ₅	mm	150	150	1312 - 1812	1312 - 1612	1812 - 2562		
	Overall height raised Form "B"	h ₄	mm	3480 - 4880	5280 - 6080	3543 - 4543	4838 - 5738	6138 - 8388		
	Overall height raised Form "A"	h ₄	mm	3473 - 4873	5273 - 6073	3543 - 4543	4838 - 5738	6138 - 8388		
	Forward tilt	a	°	3						
	Back tilt	b	°	8		6				
	Greatest width	B	mm	1138	1188	1138	1138	1188		
	Overall length	L ₂	mm	1983			2003			
	Load distance	x	mm	355			375			
	Working aisle width	A _{st}	mm	(1000 x 1200) 3309 (1200 x 800) 3433			(1000 x 1200) 3327 (1200 x 800) 3452			
	Tyres	v/h		200/50 - 10 / 16 x 6 - 8						
	Track	v/h	mm	942/168	990/168	942/168	942/168	990/168		
RX 20-18P/h	Overall length	L ₂	2108			2128				
	Working aisle width	A _{st}	(1000 x 1200) 3439 (1200 x 800) 3638			(1000 x 1200) 3459 (1200 x 800) 3658				
	Tyres	v/h	200/50 - 10 / 16 x 6 - 8							
	Track	v/h	942/865	990/865	942/865	942/865	990/865			
RX 20-20	Rated lift	h ₃	mm	2750 - 4150	4630 - 5330	2870 - 3870	4165 - 5065	5665 - 7915		
	Closed height	h ₁	mm	1960 - 2660	2910 - 3260	1960 - 2460	1960 - 2260	2460 - 3210		
	Free lift Form "B"	h ₂ /h ₅	mm	150	150	1330 - 1830	1330 - 1630	1830 - 2580		
	Free lift Form "A"	h ₂ /h ₅	mm	150	150	1405 - 1905	1405 - 1705	1905 - 2655		
	Overall height raised Form "B"	h ₄	mm	3400 - 4800	5300 - 6000	3520 - 4520	4830 - 5730	6330 - 8580		
	Overall height raised Form "A"	h ₄	mm	3325 - 4725	5225 - 5925	3445 - 4445	4755 - 5655	6255 - 8505		
	Forward tilt	a	°	3						
	Backward tilt	b	°	8		6				
	Greatest width	B	mm	1138	1188	1138	1138	1188		
	Overall length	L ₂	mm	2092			2114			
	Load distance	x	mm	365			387			
	Working aisle width	A _{st}	mm	(1000 x 1200) 3418 (1200 x 800) 3542			(1000 x 1200) 3438 (1200 x 800) 3563			
	Tyres	v/h		200/50 - 10 / 16 x 6 - 8						
	Track	v/h	mm	942/168	990/168	942/168	942/168	990/168		
RX 20-20P	Overall length	L ₂	2130			2152				
	Working aisle width	A _{st}	(1000 x 1200) 3473 (1200 x 800) 3672			(1000 x 1200) 3495 (1200 x 800) 3694				
	Tyres	v/h	200/50 - 10 / 16 x 6 - 8							
	Track	v/h	942/865	990/865	942/865	942/865	990/865			
RX 20-20Ph	Overall length	L ₂	2118			2140				
	Working aisle width	A _{st}	(1000 x 1200) 3449 (1200 x 800) 3648			(1000 x 1200) 3471 (1200 x 800) 3670				
	Tyres	v/h	200/50 - 10 / 16 x 6 - 8							
Track	v/h	mm	942/865	990/865	942/865	942/865	990/865			

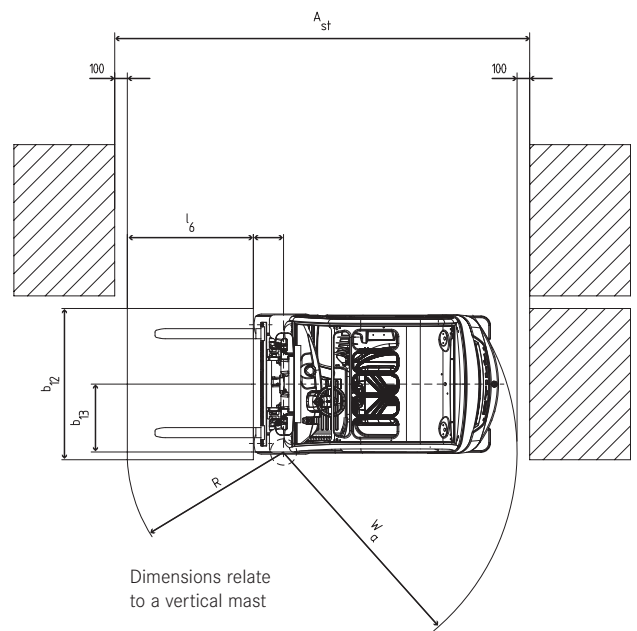
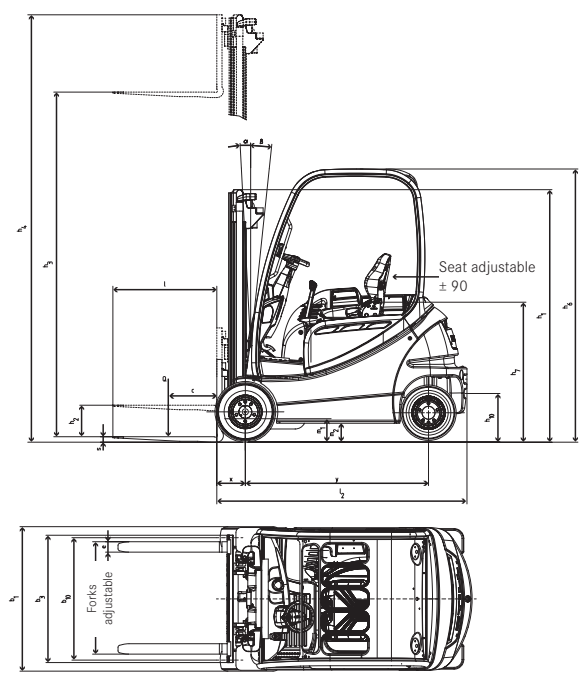

— Fork carriage
 - - - Hook-on sideshift

Capacities RX 20-15 Tele -/ HiLo - mast

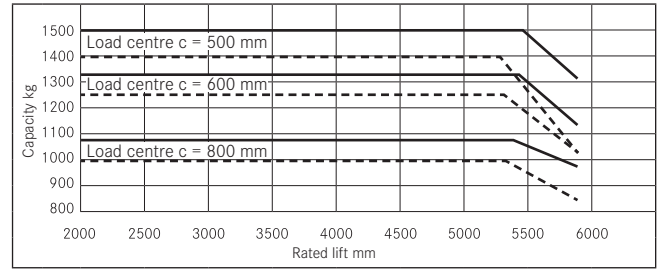

Capacities RX 20-15 Triplex mast

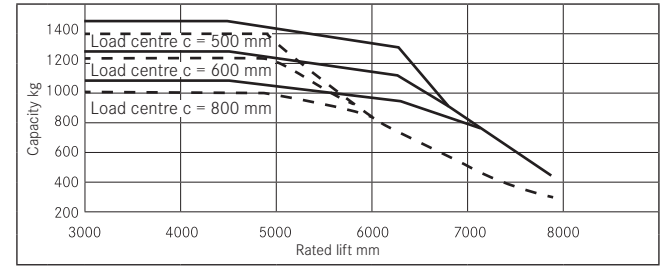

Capacities RX 20-16 Tele -/ HiLo - mast

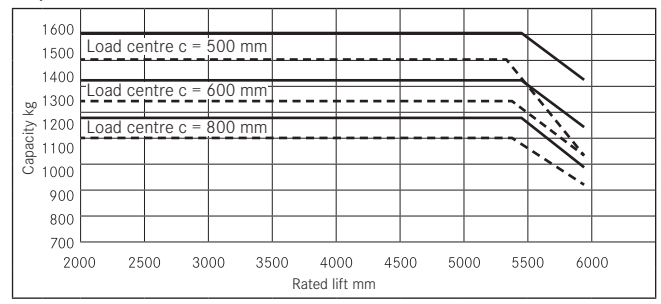

Capacities RX 20-16 Triplex mast

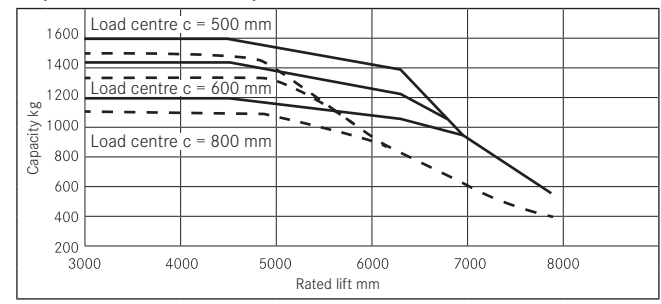

Capacities RX 20-16P Tele -/ HiLo - mast

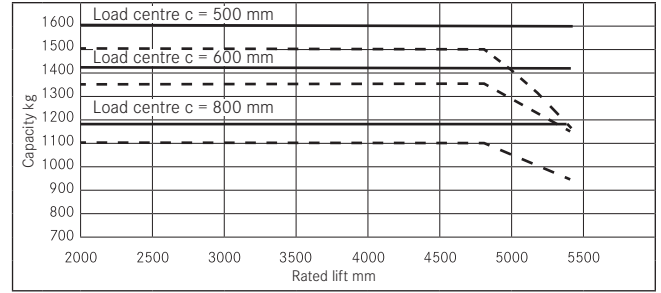

Capacities RX 20-16P Triplex mast

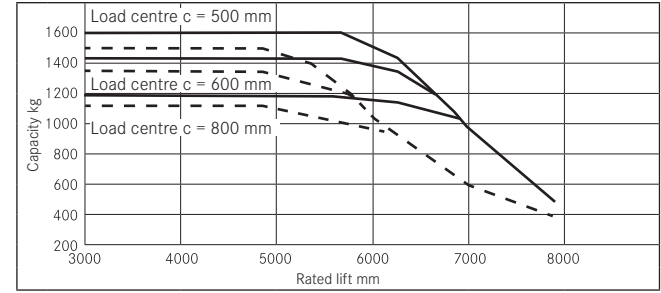

Capacities RX 20-18 Tele -/ HiLo - mast

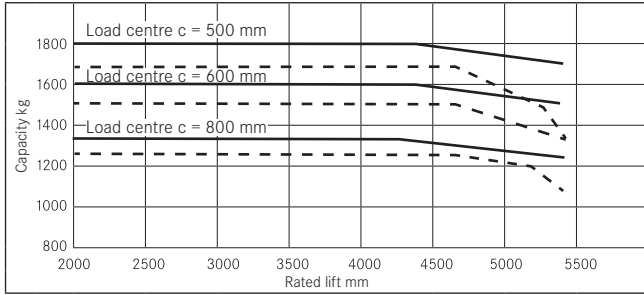

Capacities RX 20-18 Triplex mast

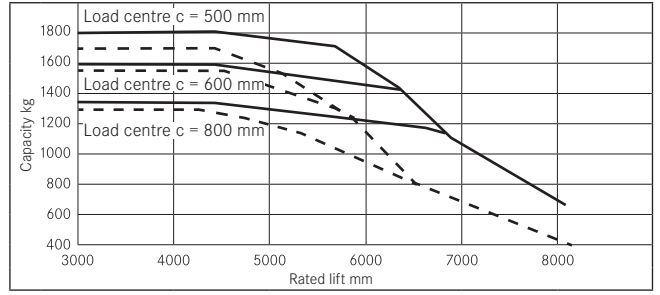

Capacities RX 20-18P/h Tele -/ HiLo - mast

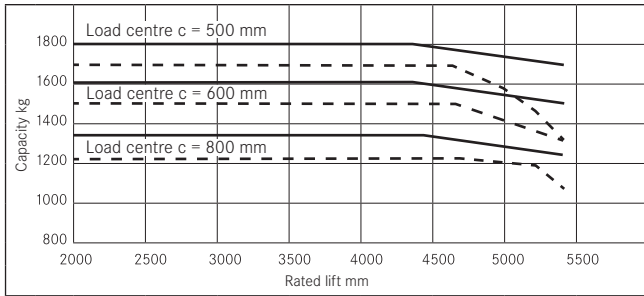

Capacities RX 20-18P/h Triplex mast

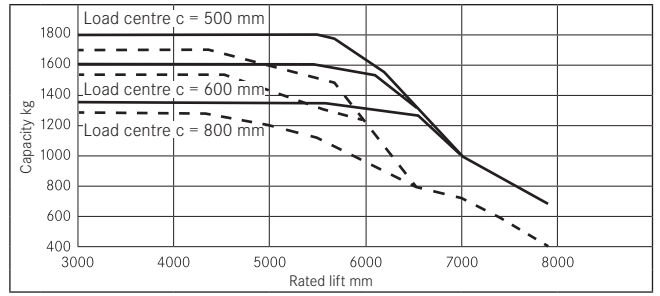

Capacities RX 20-20 Tele -/ HiLo - mast

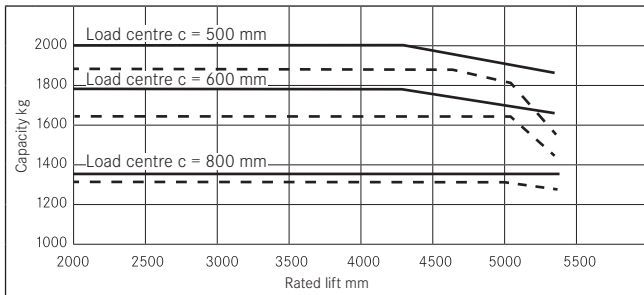

Capacities RX 20-20 Triplex mast

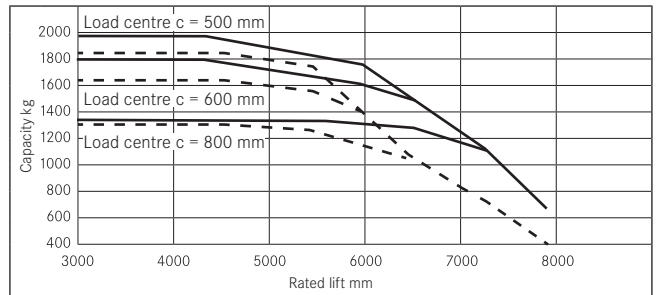

Capacities RX 20-20P Tele -/ HiLo - mast

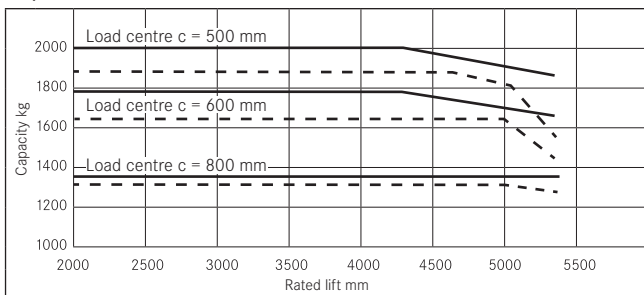

Capacities RX 20-20P Triplex mast

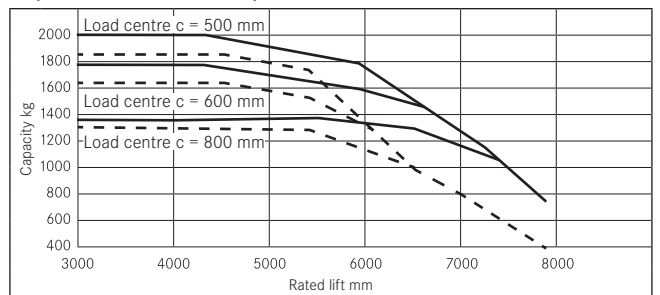

Capacities RX 20-20P/h Tele -/ HiLo - mast

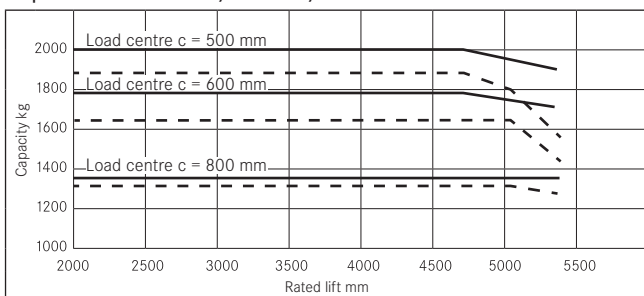

Capacities RX 20-20P/h Triplex mast

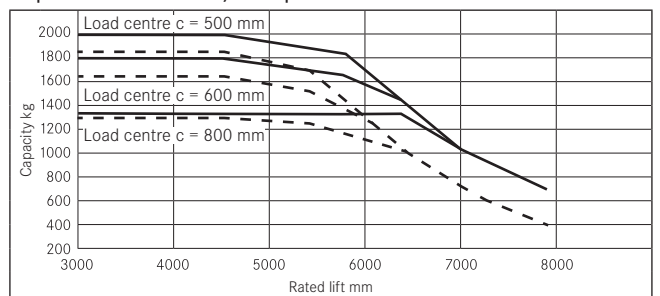

— Fork carriage
 - - - Hook-on sideshift

Drive.

Both of the energy efficient three-phase drive units of the RX 20 drive the front wheels and have optimised noise levels. High traction power and driving dynamics, whether on uneven ground or when working on ramps, ensure a high throughput of pallets. One characteristic of the RX 20's drive is the strong development of power from a standstill up to maximum speed. This ensures maximum power is readily available at kerbs or when pushing pallets. The maintenance-free and highly efficient three-phase drive guarantees a long battery operating life. Thanks to complete enclosure the whole drive is protected against the ingress of damaging dust and water spray, so that even applications in the worst conditions are no problem.

Thanks to regenerative braking the motors feed back up to 15% of the energy back into the battery when the drive pedal is released. This dramatically increases the useful time from a single battery charge by up to 1.5 hours. This means that interim battery charging, or even battery changing, is often unnecessary.

The STILL controller ensures optimum energy use and enables the truck to be held on gradients without the need to use the foot brake. The power electronics are protected within the counterweight, which acts as a heat sync. The heat from the controller is thus dissipated into the counterweight over a large area. This arrangement provides very good cooling without the need for additional fans or filters, making the truck more reliable and quieter in use.

Blue-Q energy optimisation.

- Activation of the Blue-Q efficiency mode at the push of a button.
- Saves energy without impairing throughput by intelligently optimising the truck's drive characteristics.
- Intelligently switches off electrical consumers.
- A saving in energy consumption of up to 20%, depending on the application and the truck's equipment.

Electrical system.

The electrical system on the RX 20 works digitally. The two separate CAN bus systems allow operation without repercussions on the drive train. This provides breakdown security. At the same time the robust controller with its two processors provides mutual monitoring for the greatest possible safety. Simple retro-fitting of other electrical units is possible through pre-prepared connections.

Mast.

Depending on the application, the telescopic, HiLo or triplex options offer the following:

- Telescopic: an inexpensive mast design suitable for many applications, with full visibility through the mast.
- HiLo: supplements the telescopic mast with an additional central full free lift cylinder to allow high stacking under low ceilings, e.g. for container or lorry use, right up to the roof.
- Triplex: for use where there are low doorways but high lift heights, for utilisation of warehouses right up to the roof.

Hydraulic system.

The speed of the pump motor is demand controlled and precise. It operates only when either the valve levers or steering wheel are moved, thus providing longer usage from a battery charge. The sensitive operation of the hydraulics increases working safety by positioning loads to the nearest millimetre. The hydraulics improve the energy consumption thanks to:

- The high efficiency of the noise reduced hydraulic pump.
 - The replacement of the pressure make-up valves with load holding valves.
- The priority valve for the steering is directly connected to the pump so that hydraulic interfaces and hoses are done away with. This ensures safer, cleaner operation.

Driver's compartment.

The driver's work place in the RX 20:

- The large footwell with its inclined floor plate and anti-slip covering provides quick, convenient entry and exit and also a relaxed leg position when driving.
- The adjustable steering column with its small steering wheel provides an ergonomic match to the driver and reduces steering movements.
- The automotive style foot pedal arrangement can optionally be replaced by a dual pedal arrangement.
- The drive direction switch on the valve lever (hoist and lower) aids untiring concentrated work, even during long shifts, because it allows convenient changing of the drive direction without changing grip.
- Thanks to the heated, fully graphic display, the time, maintenance intervals and battery state are clearly displayed, even when changing from cold to warm areas of use. The whole RX 20 is subjected to constant on-board diagnosis.
- With 5 selectable drive programs the driver can match the driving characteristics of the RX 20 to the application or to what is personally preferred at any time. Each program can be precisely adapted to the application profile in order to achieve optimum economy and load turnround performance.
- The driver's compartment of the RX 20 provides enough head room even for tall drivers, as well as good all round vision thanks to the large viewing panels in the roof, very slim overhead guard legs and the high seating position.

Safety.

Electrical braking when the drive pedal is released, fully automatic hold-on-ramp feature which works without using the brakes, plus the mechanical parking and service brake guarantees safe use at any time. Battery changes on the RX 20 are carried out using a hand pallet truck, low lift pallet truck, forklift truck or hoist. Along with the considerable saving in time compared with conventional craning of the battery, especially with cab variants, this concept minimizes the risk of crushing and damage of any sort that could occur with a heavy swinging battery.

Service.

The maintenance interval of the RX 20 is 1000 hours or 12 months. These intervals save time and maintenance costs - especially in single-shift operation, where 1000 hours roughly corresponds to the number of annual operating hours, thus the maintenance and annual examination can be carried out at the same time.

Quick diagnosis by laptop computer and good accessibility of all maintenance components in conjunction with the availability of all necessary parts guarantee short service times and a high level of availability for the RX 20.



Your contact

STILL GmbH

Berzeliusstraße 10

D-22113 Hamburg

Telephone: +49 (0)40/73 39-2000

Telefax: +49 (0)40/73 39-2001

info@still.de

For further information please visit:

www.still.de

STILL Materials Handling Ltd.

Aston Way, Leyland

Lancashire PR26 7UX

Telephone: +44 (0)1772 644300

Telefax: +44 (0)1772 644303

info@still.co.uk

For further information please visit:

www.still.co.uk